

Panasonic®

■ This product is eligible for the AVCCAM
3 Year Warranty Repair Program. For
details, see page 6 of vol.1.

Operating Instructions **Vol.2**

Memory Card Camera-Recorder

Model No. **AG-AC130P**

Volume **2**

Note that Operation Instructions Vol.2 describes advanced operations of the Memory Card Camera-Recorder. For instructions on basic operations of the Memory Card Camera-Recorder, refer to Operating Instructions Vol.1 (printed documents) contained in the supplied CD-ROM.

AVCCAM

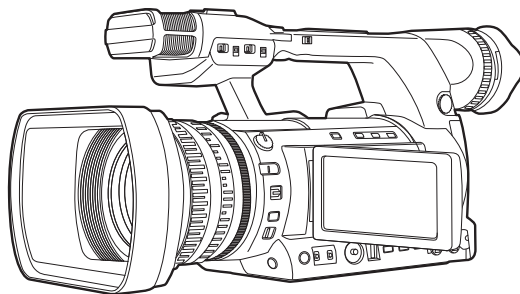

AVCHD™



DOLBY
DIGITAL
STEREO CREATOR

HDMI™
HIGH DEFINITION MULTIMEDIA INTERFACE

Before operating this product, please read the instructions carefully and save this manual for future use.

M0911S10 -Y1

ENGLISH
VQT3T61A (E)

Contents

Volume 1

Read this first!

How to use the camera
Please read before use
Operating precautions

Before use

Before using the camera
Accessories
Optional accessories

Description of parts

Description of parts

Preparation

Recharging the battery

Power sources

Adjusting the hand strap
Attaching the shoulder strap
Attaching/removing the lens hood
Attaching/removing the lens cap
Fitting the eye cup
The remote control
Turning the camera ON/OFF
Setup menu basic operations
Setting the calendar

Menu

Setup menu structure

Reference

Specifications

Volume 2

Shooting

Using the viewfinder 5

Using the viewfinder 5
Using the LCD monitor 6
Emphasizing image outlines 6
Adjusting the screen display 7
Changing backlight brightness 8
Flipping images up, down, left and right 8

Tally lamp 9

Basic shooting operations 10

Preparing for shooting 10
Shooting in Auto mode 11
Checking recorded images (REC CHECK) ... 12
Memory card access lamp 12
Selecting a slot 12
Formatting memory cards 13
Memory card recording times 14
Removing memory cards 15
Protecting memory cards 15
Repairing memory cards 16

Using the zoom function 17

Digital zoom function 17

Shooting in manual mode 18

Switching to manual mode 18
Setting focus (manual focus) 18
Using focus assist 19
Adjusting the iris 19
Adjusting the gain 20
Light intensity adjustment 20
Adjusting the white balance 20

Shooting in 1080i/480i progressive mode 23

Using convenient shooting functions 24

Low angle shooting 24
Self-portrait recording 24
Zebra patterns 25
Marker 25
Checking and displaying shooting status 25
Shooting using the <FUNCTION> knob 26
Optical image stabilizer function 27
Adding effects to images 27
Using USER buttons 27
Backlight compensation 27
Color bars 28
Changing the image size 28

Menu

Setup menu list.....	79
[SCENE FILE] screen	79
[SW MODE] screen	82
[AUTO SW] screen	84
[RECORDING SETUP] screen	85
[TC/UB SETUP] screen	87
[AV OUT SETUP] screen	88
[DISPLAY SETUP] screen	89
[CARD FUNCTIONS] screen	92
[USER FILE] screen	92
[META DATA] screen (AVCHD mode only) ...	93
[OTHER FUNCTIONS] screen	93
[OPTION MENU] screen.....	95
[PLAY SETUP] screen	95
[THUMBNAIL] screen	96
[OPERATION] screen	96

Reference

Before calling for service.....	97
Updating the firmware incorporated into the unit.....	101
Cleaning	102
Storage precautions.....	102
Recording format list	103
Index	104

Using the viewfinder

This camera utilizes a viewfinder with a miniature LCD, and a 3.45-inch LCD monitor.

Use them according to application and shooting conditions.

- Brightness and hue of images in the viewfinder and the LCD monitor may sometimes differ from those on a TV monitor.

Check final images with a TV monitor.

- Less than 0.01% of the pixels in the LCD may not light or remain on all the time. They are not defective, and will have no effect on the images you record.
- Screen burn-in may occur in the LCD monitor, however, this is not a defect.

Using the viewfinder

- 1 Turn the POWER/MODE switch of the camera <ON> (Page 27 of Vol.1), and check that images appear in the viewfinder.**

- 2 Position the screen of the viewfinder where it is easiest to see.**

The viewfinder can be raised to about 90° perpendicular to the camera.

- 3 Adjust the diopter adjustment dial so that you can see the characters on the finder screen clearly.**

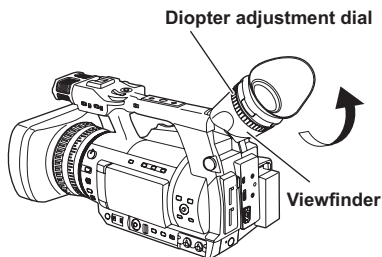

- **Do not leave the eyepiece of the viewfinder pointed in the direction of the sun or strong light sources.**

Internal components may be damaged or fire may be caused if light is focused through the lens.

- When the LCD monitor is open, the viewfinder may not display anything. Close the LCD monitor. (Page 66)

Using the LCD monitor

- 1 Turn the **POWER/MODE** switch of the camera <ON>. (Page 27 of Vol.1)
- 2 Open the LCD monitor.
The monitor opens to an angle of 90°. The camera may be damaged by attempting to open it further than this.

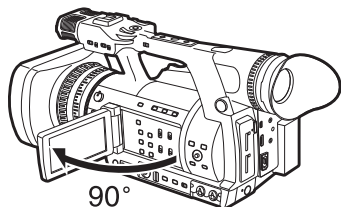

- 3 Position the screen of the LCD monitor where it is the easiest to see.
 - The monitor can be rotated 180° toward the lens and 90° toward you.
 - Do not apply unnecessary force to the open LCD monitor. This can damage the camera.

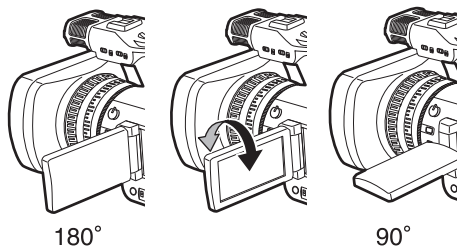

Emphasizing image outlines

Emphasizing the outlines of images in the viewfinder or the LCD monitor makes it easier to focus.

Emphasizing outlines does not affect recorded images.

- 1 In <CAMERA> mode, press the <EVF DTL> button.

[EVF DTL ON] appears in the center of the screen for approximately two seconds.

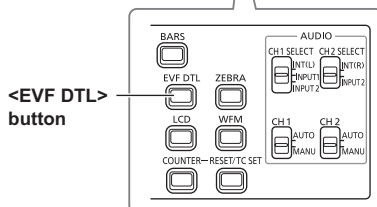
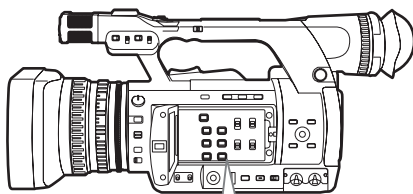

Press the <EVF DTL> button again to return to the original display. Then, [EVF DTL OFF] appears in the center of the screen for approximately two seconds.

- When closing the LCD monitor, ensure that it is closed.
- Operation status displays when shooting a self-portrait
No display: You cannot record (no memory card, etc.)

[○]: Shooting in progress, during transition to shooting pause

[□]: Shooting paused (shooting standby)

[!]: Warning display in progress

Adjusting the screen display

- 1 Turn the POWER/MODE switch of the camera <ON>. (Page 27 of Vol.1)
- 2 Press the <MENU> button.
 - Menu operation (Page 28 of Vol.1)
 - Operations may be performed with buttons on the remote control that correspond to those on the camera. For details, see “Remote control” (Page 21 of Vol.1).

- 3 **Viewfinder adjustments**
 Select [YES] in the [EVF SET] item on the setup menu [DISPLAY SETUP] screen.

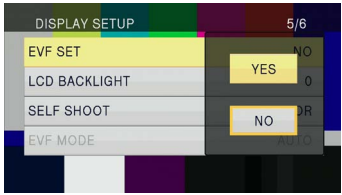

- 4 **LCD monitor adjustments**
 Select [YES] in the [LCD SET] item on the setup menu [DISPLAY SETUP] screen.

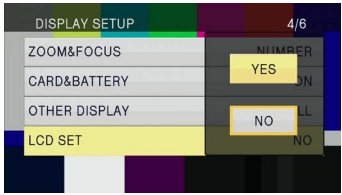

- 4 Select desired items by tilting the OPERATION lever in the <▲> or <▼> directions, and push the OPERATION lever.



- 5 Adjust the selected item by tilting the OPERATION lever in the <▲> or <▼> direction.



- 6 Press the <MENU> button to release menu mode.
 - Color or monochrome viewfinder display can be selected with the [EVF COLOR] item of the [DISPLAY SETUP] screen. Resolution is the same for either of them.

Changing backlight brightness

The brightness of the LCD monitor backlight can be adjusted between five different settings.

1 Select [LCD BL] in the [LCD] item on the setup menu [SW MODE] screen.

[LCD BL] is assigned to the <LCD> button.

2 Press the <LCD> button.

Each time the button is pressed, the backlight brightness changes in the following order:

0 (normal)→-1 (somewhat dark)→-2→-3 (dark)→+1 (bright)→0 (normal).

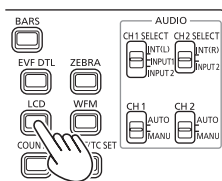

- The setting will be saved even if the power is switched off.
- It can also be switched with the [LCD BACKLIGHT] item on the setup menu [DISPLAY SETUP] screen. (Page 91)

Flipping images up, down, left and right

By flipping the images displayed on the LCD monitor up, down, left and right, the angle of view and imagery of images can be checked. Even when the displayed image is flipped, the recorded image is not flipped.

1 Select [LCD REV] in the [LCD] item on the setup menu [SW MODE] screen.

[LCD REV] is assigned to the <LCD> button.

2 Press the <LCD> button.

Pressing the button switches between normal display and flipped display.

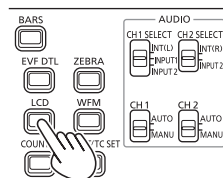

- If the power of the camera is switched off, it will appear in normal display when next switched on.
- Screen displays other than images are also flipped. When screen display is not needed, press the <DISP/MODE CHK> button to turn off some displays.
- During flipped display, images in REC CHECK and playback images in <PB> mode are also flipped.
- Images on the viewfinder are not flipped.

Tally lamp

The tally lamp lights during recording by setting the [TALLY LAMP] item of the [OTHER FUNCTIONS] screen (Page 94) to any setting other than [OFF]. The tally lamp will flash when the camera is in any of the following circumstances.

- When a recording error has occurred (flashes 4 times per second)
- When the battery has run out (flashes 4 times per second)
- When available memory card capacity is low (flashes 4 times per second)
- When battery level is low (flashes once per second)
- When remaining memory of the memory card is low (flashes once per second)

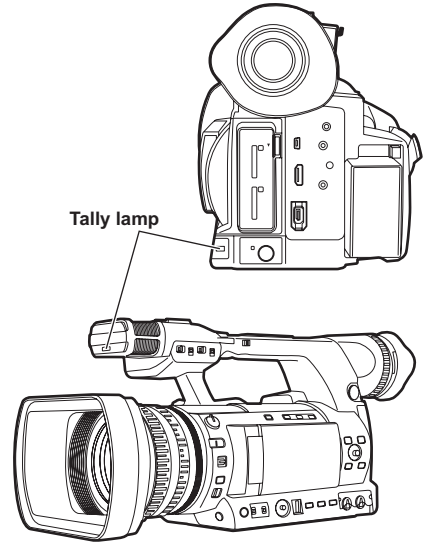

Basic shooting operations

Preparing for shooting

- 1 Turn the POWER/MODE switch of the camera <ON>. (Page 27 of Vol.1)**
 - Make sure the mode lamp is lit.
- 2 Slide the <OPEN> lever of the memory card slot cover down to open the cover.**
- 3 Fully insert a memory card with the notch up into the memory card slot.**
- 4 Close the memory card slot cover.**
 - Close until it clicks firmly into place.

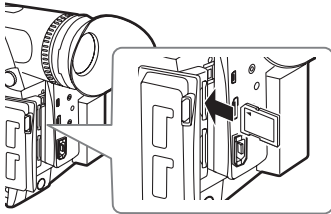

Insert from the terminal side straight forward as shown in the picture, until you hear a “click”.

- When recording is paused after a short recording, time may be required after pressing the <START/STOP> button before writing to the memory card is completed. This means that if the <START/STOP> button is pressed, operations cannot be accepted immediately.
- The camera reads information from the memory card immediately after the memory card is inserted, therefore, after [PAUSE] is displayed in the operation status display (Page 72), press the <START/STOP> button to start shooting.
- The recording formats of factory default are [PH 1080/60i] in AVCHD mode, and [DV 480/60i] in DV mode. To check current setting status, see “Checking and displaying shooting status” (Page 25).
- The upper limit for the number of clips that can be recorded in AVCHD mode on a single memory card is 900. (However, this number may exceed 900 clips when shooting immediately after the POWER/MODE switch has been turned <ON>.)
The upper limit for the number of clips that can be recorded in DV mode is 900.

- Do not perform the following operations while the memory card access lamp is flashing. You may damage the memory card or its contents, or cause the camera to fail to operate correctly.
 - Opening the door and removing the memory card
 - Switching off the power
 - Connecting and disconnecting the USB2.0 connection cable
 - Removing the battery
 - Shaking or striking the camera
- Always format memory cards that have been used on other devices when first using them with this camera. (Page 13)
- If [CHECK CARD.] (check the memory card.) is displayed on the viewfinder or LCD monitor, remove the memory card and reinsert it.
- Images shot from the start of shooting until it is stopped, are recorded as one clip.

Switching AVCHD mode/DV mode

- 1 Turn the **POWER/MODE** switch of the camera **<ON>**. (Page 27 of Vol.1)
- 2 Press the **<MENU>** button.
- 3 Select **[AVCHD]** or **[DV]** in the **[HD/SD MODE]** item on the setup menu **[RECORDING SETUP]** screen.
- 4 If the message **[TURN POWER OFF]** is displayed, switch off the power and switch it on again.
The mode is switched by turning the power on and off again.
 - For how to turn the power on and off, see page 27 of vol. 1.
 - When you switch to AVCHD mode, <HD> indicator lights in blue.
 - When you switch to DV mode, <HD> indicator is turned off.

Shooting in Auto mode

- 1 Turn the **POWER/MODE** switch of the camera **<ON>**. (Page 27 of Vol.1)
 - Make sure the mode lamp **<CAMERA>** is lit in red.
- 2 Set the **<AUTO/MANU>** switch to **<AUTO>**.
 - **[A]** is displayed at the top of the LCD monitor and in the viewfinder.
 - In accordance with setting of items on the setup menu **[AUTO SW]** screen, focus, gain, iris, and white balance are adjusted automatically.

In Auto mode, the face detection function can be used by assigning **[FACE DETECT]** to a USER button. This function automatically detects faces, focuses on them, and adjusts the brightness to an appropriate level. When **[FACE DETECT]** is set, **[A]** appears on the screen.

High-priority frames with orange borders appear on the faces that are large or near the center, and gray frames appear on the others. Up to 15 detected frames are displayed on the screen.

If **[PRIMARY]** is set in the **[FACE FRAMING]** item of the setting menu **[SW MODE]** screen, only the high-priority orange frames are displayed.

- The **[FACE DETECT]** function is released in the following cases.
 - When setting the **<AUTO/MANU>** switch to **<MANU>** position
 - When switched to **<PB>** mode
 - When turning off the power of the camera
- The **[FACE DETECT]** function can be set even when setting the **<AUTO/MANU>** switch to **<MANU>** position. **[A]** will be displayed on the screen.

- 3 Press the **<START/STOP>** button to start shooting.
 - Press the **<START/STOP>** button again to pause shooting.
 - When shooting at a low angle, it is convenient to use the **<START/STOP>** button on the side of the handle. Locking with the **<HOLD>** switch prevents unintentional operation. (Page 24)
 - When the menu screen is displayed, shooting is not possible. After closing the menu screen, press the **<START/STOP>** button.
 - When the memory card slot cover is opened during shooting, shooting stops.

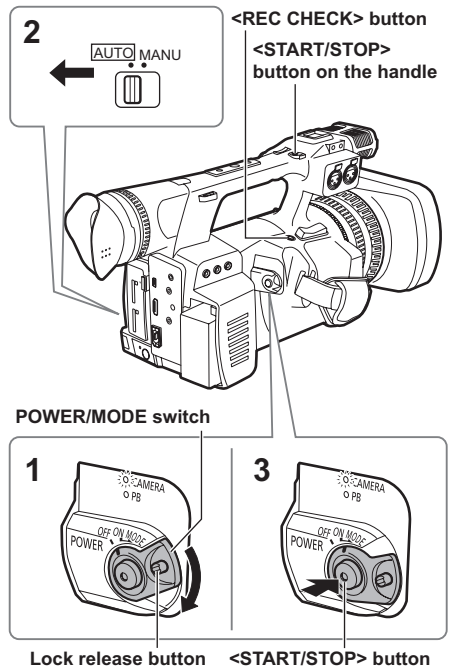

Checking recorded images (REC CHECK)

While shooting is paused, press the <REC CHECK> button to review the video and audio recorded three seconds immediately prior. After reviewing, the camera returns to the recording pause status.

- The REC CHECK images are also recorded when a device is connected to the camera and backup images have been recorded.
- When the operation mode is <PB> mode, REC CHECK does not work.
- This function does not work if the [REC FORMAT] is changed, if the camera is set to the <CAMERA> mode after having been switched to the <PB> mode, if the memory card slot cover is opened, or if the slot is switched after shooting.
- This function does not work with SIMUL REC.

Memory card access lamp

Illuminated orange:

Reading, writing possible

Flashing orange (slow):

Accessing memory card

Flashing green:

Memory card write-protected, the slot with [CHECK CARD.] indication, no space left on memory card

Illuminated green:

Other than the selected slot

Off:

No memory card inserted, unformatted memory card, or incompatible memory card inserted

When the USB is connected

Flashing orange:

Accessing memory card

Off:

A status other than access underway

Memory card access lamp

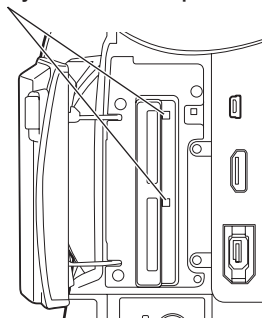

Selecting a slot

The slot to be used for recording can be switched between the two memory card slots.

1 Press the <SLOT SEL> button while the camera is standby for recording.

The access lamp of the slot for recording lights up orange.

- This function works when a recordable memory card is inserted in both slots.
- The slot cannot be switched during recording.

Formatting memory cards

- 1** Turn the **POWER/MODE** switch of the camera <ON>. (Page 27 of Vol.1)
- 2** Press the <MENU> button.
- 3** Press the **OPERATION** lever on the [**CARD FORMAT**] item on the setup menu [**CARD FUNCTIONS**] screen.
 - Select the **SLOT** number of the memory card to format when the following screen is displayed. Select [**NO**] when you do not wish to format the memory card.
 - Press the <MENU> button to close the menu display.

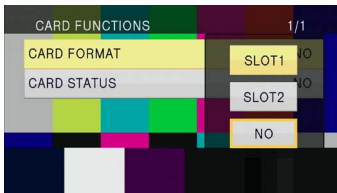

- 4** Select [**YES**] on the confirmation screen.
 - The memory card will be formatted.

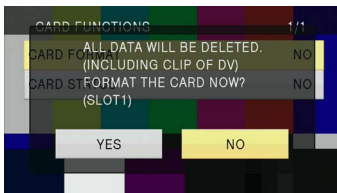

- 5** Press the <MENU> button to finish.
 - When a memory card is formatted, all data including video images recorded on the memory card will be erased and cannot be restored. Save important data to your computer.

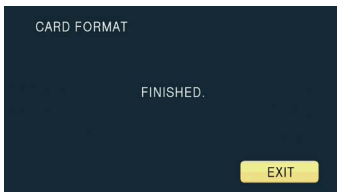

Memory card recording times

- Recording times (approx.) when using Panasonic SD/SDHC/SDXC memory cards

Recording mode Memory card capacity	AVCHD mode				DV mode
	PH ¹ (Highest quality mode ³ /1920X1080 pixels or 1280X720 pixels)	PM ² (Long duration mode/1280X720 pixels)	HA ¹ (High quality mode/1920X1080 pixels)	HE ² (Long duration mode/1440X1080 pixels)	DV
512 MB	Approx. 2 min	Approx. 5 min	Approx. 3 min	Approx. 10 min	Approx. 2 min
1 GB	Approx. 5 min	Approx. 12 min	Approx. 7 min	Approx. 21 min	Approx. 4 min
2 GB	Approx. 10 min	Approx. 25 min	Approx. 15 min	Approx. 45 min	Approx. 8 min
4 GB	Approx. 21 min	Approx. 52 min	Approx. 30 min	Approx. 1 hr 30 min	Approx. 16 min
6 GB	Approx. 33 min	Approx. 1 hr 20 min	Approx. 45 min	Approx. 2 hr 15 min	-
8 GB	Approx. 45 min	Approx. 1 hr 50 min	Approx. 1 hr	Approx. 3 hr	Approx. 32 min
12 GB	Approx. 1 hr 5 min	Approx. 2 hr 50 min	Approx. 1 hr 30 min	Approx. 4 hr 30 min	-
16 GB	Approx. 1 hr 30 min	Approx. 3 hr 45 min	Approx. 2 hr	Approx. 6 hr	Approx. 1 hr 4 min
32 GB	Approx. 3 hr	Approx. 7 hr 30 min	Approx. 4 hr	Approx. 12 hr	Approx. 2 hr 8 min
48 GB	Approx. 4 hr 30 min	Approx. 11 hr 20 min	Approx. 6 hr	Approx. 18 hr	Approx. 3 hr 12 min
64 GB	Approx. 6 hr	Approx. 15 hr	Approx. 8 hr	Approx. 24 hr	Approx. 4 hr 16 min

■ AVCHD mode

*1 Use a memory card of SD speed class 4 or above when recording with PH mode/HA mode. Recording cannot be performed with a memory card of lower than SD speed class 4.

*2 Use a memory card of SD speed class 2 or above when recording with PM mode/HE mode.

*3 This is the highest quality mode of the camera.

- The camera utilizes the VBR recording system. VBR stands for Variable Bit Rate, a recording system where the bit rate automatically varies (volume of data per given time period) according to the subject being shot. Therefore, recording times will be shorter when fast moving subjects have been recorded.
- Control space is included in the displayed capacity, and available recording capacity will be smaller.
- Continuous recording time is a maximum of 12 hours (when using the AC adaptor).
- Recording can be sometimes restarted even if it was paused due to shortage of space.
- Even for the same memory card, the recording time differs depending on conditions such as the recording format or recorded images.
- The recording time of a memory card may shorten when record and delete are repeated often over and over. In that case, format the memory card with the camera. When a memory card is formatted, all data recorded on the memory card is erased and cannot be restored. Save important data to your computer.

■ DV mode

- Use a memory card of SD speed class 6 or above when recording with DV mode. Recording cannot be performed with a memory card of lower than SD speed class 6.
- Control space is included in the displayed capacity, and available recording capacity will be smaller than that.
- Continuous recording time is a maximum of 12 hours (when using the AC adaptor).
- The recording time of a memory card may shorten when record and delete are repeated often over and over. In that case, format the memory card with the camera. When a memory card is formatted, all data recorded on the memory card is erased and cannot be restored. Save important data to your computer.
- Partition of clips recorded on a memory card

When an SDHC memory card of 8 GB or above is used, if the recording space of a single clip exceeds 4 GB, it is automatically saved as a separate clip. Saved data can be manipulated as a single clip during thumbnail operation of the camera. When handled with nonlinear editing software or a computer, clips are handled as the separate clips.

Removing memory cards

1 Slide the <OPEN> lever of the memory card slot cover down to open the cover.

- Ensure that the memory card access lamp is not flashing orange before opening the cover.

2 Press the center of the memory card, and pull the memory card straight outwards.

Memory card access lamp

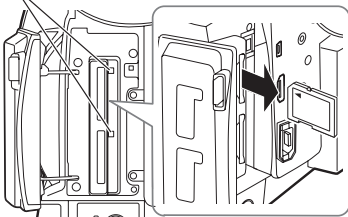

- Do not remove the memory card or switch off the power at the following times, because doing so may damage the memory card.
 - After inserting a memory card, while the orange memory card access lamp is still flashing until it changes to illuminated.
 - While the memory card access lamp is flashing such as during shooting or during shooting finalization.

Protecting memory cards

Move the write-protect switch on the memory card to the <LOCK> position to prevent recorded content from being accidentally erased from the memory card.

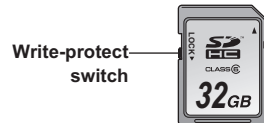

Repairing memory cards

■ For AVCHD mode

Never remove the memory card or disconnect the battery or DC cord while the memory card access lamp is flashing, since this may damage the memory card. If the memory card has been removed while the memory card access lamp was flashing, or the power was cut because the battery or DC cord has been disconnected during recording or the recording finalization process, a repair verification screen will be displayed the next time the power is switched on in order to allow errors to be repaired.

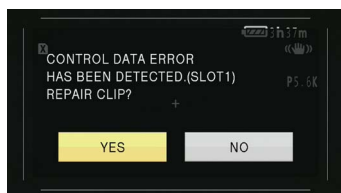

Select [YES] to begin repair, and when repair is completed, [REPAIR FINISHED] will be displayed and the camera will switch to the shooting paused screen.

Select [NO] to switch directly to the shooting paused screen without repair.

- Memory cards cannot be repaired with the camera if [NO] is selected, but can still be repaired by using the AVCCAM Restorer* contents repair software.
- A memory card on which an error occurred can be repaired by either using the camera that was used for shooting, or the AVCCAM Restorer contents repair software.
- A repair confirmation message may be displayed after inserting a memory card which has no error, but repair will not be performed even when [YES] or [NO] is selected.
- Repair may take up to approximately 20 minutes depending on the places where the errors occurred on the memory card.

- Use a battery with an adequate charge, or the AC adaptor.
 - If the repair operation has failed [SYSTEM ERROR TURN POWER OFF] will be displayed. In this case, use the AVCCAM Restorer contents repair software.
 - Depending on the status of the data, it may not be possible to restore all data completely. In this case, it will no longer be possible to play back the clips that were recorded before the power was turned off.
 - Clips with a total shooting time of less than 10 seconds may not be repaired.
 - Indexes attached during shooting cannot be repaired.
 - To repair the two memory cards that recorded video with SIMUL REC, follow the instructions displayed on the repair verification screen and repair each of the memory cards.
- * AVCCAM Restorer is included on the supplied CD-ROM. Refer to install.txt for the installation method. For details on how to use it, read the Operating Instructions (PDF file).

The AVCCAM Restorer can also be downloaded from the following website.

<http://pro-av.panasonic.net/>

■ For DV mode

For repair in DV mode, refer to "Repairing clips (only in DV mode)" (Page 58).

Using the zoom function

This camera is equipped with 22 power optical zoom. Operate zoom with either the zoom lever or the zoom ring.

Zoom lever

When the <ZOOM> switch is put in the <SERVO> position, zoom can be operated with the zoom lever by means of motor drive.

<T>: Zoom in

<W>: Zoom out

Push the zoom lever on the hand strap lightly to zoom slowly, and push it strongly to zoom quickly.

The operation speed of zoom with the zoom lever on the handle can be switched among three speeds with the <HANDLE ZOOM> switch.

Speed setting of the <HANDLE ZOOM> switch can be changed with the [HANDLE ZOOM] item of the setup menu [SW MODE] screen. (Page 82)

Zoom lever (handle side)

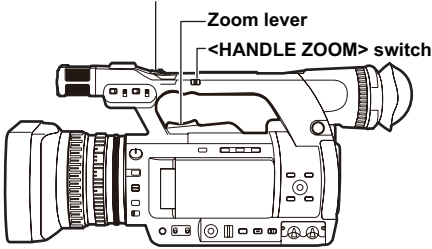

Zoom ring

When the <ZOOM> switch is put in the <MANU> position, zoom can be operated manually with the zoom ring.

- When the <ZOOM> switch is in the <SERVO> position, do not perform zoom operation manually. It may result in damage.

Zoom ring

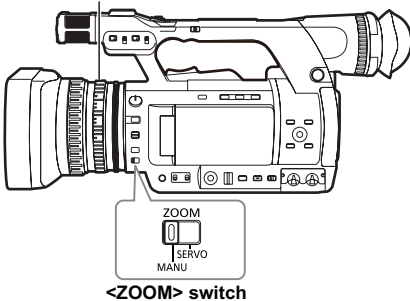

Operating remote control

Zoom is operated with the motor drive when the <ZOOM>/<VOL> button is pressed.

- Zoom speed is fixed at medium.

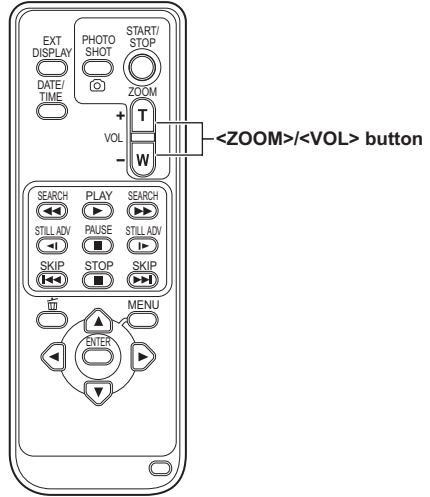

Digital zoom function

The digital zoom function can be used by assigning [D.ZOOM] to a USER button. (Page 27 , 83)

When the USER button to which [D.ZOOM] was assigned is pressed, the resolution switches through the sequence OFF (X 1)→X 2→X 5→X 10→OFF (X 1).

- Image quality is coarse to the extent that zoom ratio is large.
- When other than OFF (X 1) is selected, the current resolution is displayed in the viewfinder and the LCD monitor.
- The digital zoom function is not available when the AREA function using the <FUNCTION> knob is activated. (Page 26)

Shooting in manual mode

Set the camera to manual mode to adjust the focus, iris, gain and white balance manually.

Switching to manual mode

Set the <AUTO/MANU> switch to the <MANU> position to switch to manual mode. ([A]) display of the viewfinder and the LCD monitor disappears.)

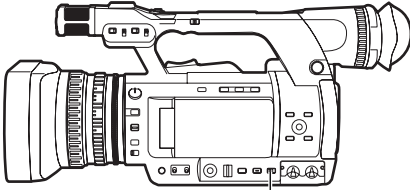

<AUTO/MANU> switch

Setting focus (manual focus)

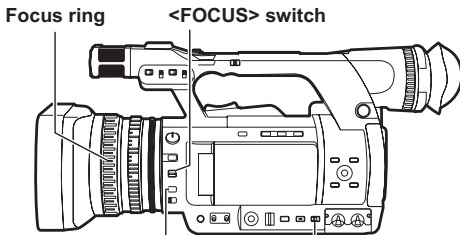

<PUSH AUTO> button <FOCUS> switch
<AUTO/MANU> switch

- 1 With the <AUTO/MANU> switch, switch to manual mode.
- 2 With the <FOCUS> switch, switch the focus control method.
 - <A> (AUTO):
Auto focus mode
Automatically sets the focus.
 - <M> (MANUAL):
Manual focus mode
Manually move the focus ring to set the focus.
 - <∞>:
After setting focal distance to infinity, automatically switched to the manual focus mode. The <FOCUS> switch automatically moves back to <M> (MANUAL) even when you move it to <∞>.

Temporarily go into auto focus mode

Even if the <FOCUS> switch is in the <M> (MANUAL) position, while pressing the <PUSH AUTO> button, the camera goes into auto focus mode, and the focus can be set automatically.

Switching to manual focus assist mode

You can switch from manual mode to manual focus assist mode by turning [ON] the [MF ASSIST] item on the setup menu [SW MODE] screen.

- Focus adjustment is performed roughly with about half the work in focus ring operation, compared to the manual focus mode.
- After adjustment with the focus ring, focus adjusts automatically (fine adjustment).
- When focus is off a great deal, it may not be set.
- After making an automatic adjustment, the next automatic adjustment is not performed until the focus ring is moved.
- Because auto focus sometimes does not operate correctly when there is flickering, select a shutter speed appropriate to the lighting. (Page 34)
- When using auto focus mode with any format other than 60i and 60P, the time for the focus control will be slightly longer than for the normal focus mode.
- When [ON] is selected in the [AF] item on the setup menu [AUTO SW] screen, auto focus is on during auto mode regardless of the position of the <FOCUS> switch. (Page 84)
- During macro shooting, the screen display of [AF], [MF], and [MA] become boxed characters.

Using focus assist

When you press the <FOCUS ASSIST> button, the screen border turns red and the image contour has red edges. Adjust the focus so that the contour of the subject you want to focus on becomes red.

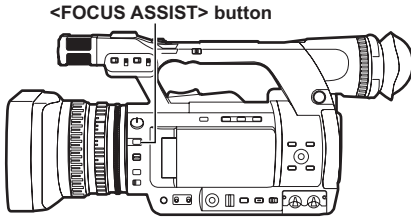

Adjusting the iris

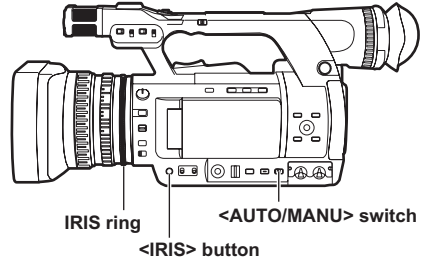

1 Use the <AUTO/MANU> switch, to switch to manual mode. (Page 18)

2 Press the <IRIS> button to switch the lens aperture adjustment method.

[AUTO IRIS]: (auto iris)

Automatically adjusts the iris value.

[MANUAL IRIS]: (manual iris)

Manually adjusts lens aperture.

3 When manual iris is on, adjust the lens aperture by turning the IRIS ring.

- When auto iris is on, use this ring to correct lens aperture.
- When [ON] is selected in the [A.IRIS] item on the setup menu [AUTO SW] screen, during auto mode, auto iris is turned on forcibly. (Page 84)
- See the display on the IRIS METER display for the status of the light intensity. See page 75 regarding IRIS METER display.

- Regarding the F values when the lens aperture is open on this camera, [F1.6] is the wide angle side (W) end, and [F3.2] is the telescopic side (T) end. In the iris display displayed on the viewfinder and the LCD monitor when the lens aperture is open, [OPEN] is displayed on the wide angle side (W) end, and [F3.2] or [OPEN] is displayed on the telescopic side (T) end.
- When the iris is near closed, resolution goes down due to light diffraction. In this case, you can improve things by adjusting shutter speed, and not letting the iris close.

Adjusting the gain

When the screen of the camera is dark, you can make the screen bright by raising the gain.

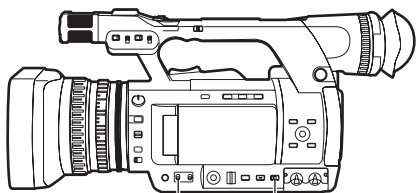

<GAIN> switch <AUTO/MANU> switch

1 Use the <AUTO/MANU> switch, to switch to manual mode. (Page 18)

2 Use the <GAIN> switch to switch the gain.

<L>:

Normally, put it in this position.
(Factory setting is 0 dB)

<M>:

Raises the gain of the camera image amp.
(Factory setting is 6 dB)

<H>:

Raises the gain of the camera image amp.
(Factory setting is 12 dB)

- Gain value of <L>/<M>/<H> can be changed in the [LOW GAIN]/[MID GAIN]/[HIGH GAIN] item on the setup menu [SW MODE] screen. (Page 82)

Especially when gain adjustment is necessary, assign the [S.GAIN] item to any of the <USER1> - <USER3> buttons. Each time the assigned button is pressed, you can switch between normal gain/super gain. When setting super gain, select [24dB] or [30dB] in the [SUPER GAIN] item on the [SW MODE] screen.

- When other than [OFF] is selected with the [AGC] item on the setup menu [AUTO SW] screen, auto gain is on during auto mode regardless of the position of the <GAIN> switch. (Page 84)

Light intensity adjustment

When natural light is strong, use the <ND FILTER> dial to switch the ND filter (light intensity adjustment filter) to use.

<OFF>:

ND filter is not used.

<1/4>:

Intensity of light is cut to approx. 1/4.

<1/16>:

Intensity of light is cut to approx. 1/16.

<1/64>:

Intensity of light is cut to approx. 1/64.

<ND FILTER> dial

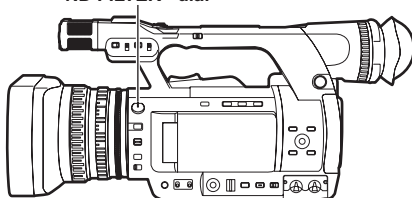

Adjusting the white balance

To reproduce white accurately, adjust the proportion of the primary colors RGB. When the white balance is wrong, not only the reproduction of white is bad, but also the color tone of the whole screen becomes bad.

When shooting in manual mode, if light conditions change, always adjust the white balance.

The adjusted value for white balance can be saved on the <A> and positions of the <WHITE BAL> switch.

Also, you can use the preset values already in the memory. Use the memory according to shooting conditions.

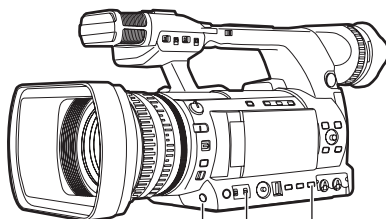

<AUTO/MANU> switch

<WHITE BAL> switch

<AWB> button

Adjusting white balance

- 1** Use the <AUTO/MANU> switch, to switch to manual mode. (Page 18)
- 2** Set the shutter speed. (Page 34)
- 3** Place a white pattern in a place with the same light source conditions as the subject, then zoom in and reproduce the white on the full screen.
White objects close to the subject (white cloth, white walls) can be substituted.
 - Do not allow bright spotlights within the screen.
- 4** Move the <WHITE BAL> switch to the position of <A> or (position to save white balance adjusted value).
- 5** Press the <AWB> button.

- Adjustment is completed in a few seconds. (The following message is displayed.)

Message during adjustment:

[AWB Ach ACTIVE]

Message when adjustment is completed:
[AWB Ach OK]

- When white balance cannot be adjusted automatically, an error message is displayed in the viewfinder and on the LCD monitor screen.

Message when adjustment cannot be made:

[AWB Ach NG]

- White balance cannot be adjusted if the [ATW] (Auto Tracking White) function is working.
- When [ON] is selected in the [ATW] item on the setup menu [AUTO SW] screen, regardless of the position of the <WHITE BAL> switch, [ATW] is on during auto mode. (Page 84)
- When the following error messages are displayed, try to adjust white balance again after performing remedies.

Error message	Adjustment method
[LOW LIGHT]	Increase light intensity. Or, raise the gain.
[LEVEL OVER]	Decrease light intensity. Or, lower the gain.

- When the error messages are displayed after repeated attempts, consult your dealer.

Using preset values

This is convenient when there is no time to adjust white balance.

- 1** Use the <AUTO/MANU> switch, to switch to manual mode. (Page 18)
- 2** Set the <WHITE BAL> switch to <PRST>. The current white balance value is displayed.
 - White balance values 3200 K and 5600 K are preset in the <PRST> position.
Guidelines for preset values
P3.2K (3200 K): Halogen light
P5.6K (5600 K): Natural light
- 3** Press the <AWB> button.
The white balance value switches in the following order: 3200 K, 5600 K, VARIABLE.

- Selecting VARIABLE enables the white balance to be set to an optional value between [P2.4K] and [P9.9K] by moving the <FUNCTION> knob up and down.
- The VARIABLE white balance value displayed is not guaranteed to be an absolute value. Use it as a reference value.
- The VARIABLE white balance value can be checked by pressing the <AWB> button.
- The value of VARIABLE cannot be changed when the AREA function of the <FUNCTION> knob is operating and a frame is displayed.

Adjusting black balance

To reproduce black accurately, align the zero level of the primary colors RGB.

When the black level is wrong, not only the reproduction of black is bad, but also the tone of the whole screen becomes bad.

Usually there is no need to adjust black balance, but adjustment is required in the following cases.

- When using the camera for the first time
- When using the camera after not using it for a long time
- When using in conditions where the surrounding temperature has changed greatly
- After changing the GAIN and shutter speed
- After switching from <PB> mode to <CAMERA> mode

Press the <AWB> button to adjust white balance automatically, and continue to press it to adjust black balance. Do so after preparing conditions to adjust white balance.

Message during adjustment:

[ABB ACTIVE]

Message when adjustment is completed:

[ABB END]

-
-
- Even when the [ATW] function is in use, continue to press the <AWB> button to adjust black balance.
 - Black balance cannot be adjusted during shooting.
-
-

[ATW] (Auto Tracking White) function

The [ATW] function automatically decides the shooting environment and always automatically adjusts for optimal white balance during shooting. The [ATW] function can be assigned to the <WHITE BAL> switch (either <A>//<PRST> position) in the [ATW] item on the setup menu [SW MODE] screen. (Page 82)

Also, the factory setting allows the [ATW] function to work in auto mode. (Page 84)

Natural light sensor

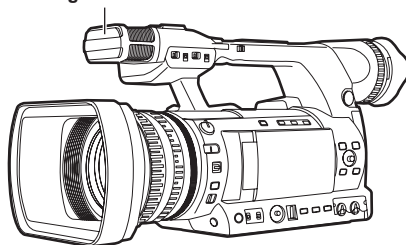

-
-
- Some adjustment error may occur depending on the environment.
 - Perform white balance adjustment (Page 20) when high accuracy white balance adjustment is required.
 - This camera is equipped with a natural light sensor to assist the [ATW] function. When shooting using the [ATW] function, do not block the natural light sensor with your hand.
-
-

Shooting in 1080i/480i progressive mode

You can shoot in progressive mode when you select 30P, 24P for 1080 mode in AVCHD mode or 30P, 24P for 480 mode in DV mode in the [RECORDING FORMAT] item on the setup menu [RECORDING SETUP] screen. (Page 85)

30P mode:

Shoots 30 frames/second in the progressive mode.
 For output and recording of video signal, the 30 frames/second image is converted to 60-field-per-second interlace signal.
 This mode gives high quality video.



24P mode:

Shoots 24 frames/second in the progressive mode.
 Video signals are recorded as native. (AVCHD mode only)
 For output and recording of video signal, the 24 frames/second image is converted with a general 2:3 conversion method to 60-field-per-second interlace signal.
 This mode gives video with a movie feeling.

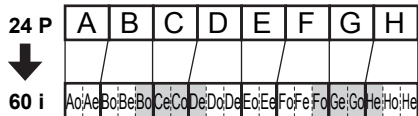

When shooting in progressive mode, be careful about the followings.

- We recommend that you set shutter speed to 1/50 (OFF).
- When shooting in 24P mode of 1080 mode, because recording is performed in 4-frame units, recording may start a little late.
- When shooting in 24P mode of 480 mode, recording is performed in 5-frame units.

Using convenient shooting functions

Low angle shooting

When shooting at a low angle, it is convenient to use the <START/STOP> button on the side of the handle. Release the <HOLD> switch and press the button to start shooting.

- When not using the <START/STOP> button on the handle, lock it with the <HOLD> switch to prevent unintentional operation.

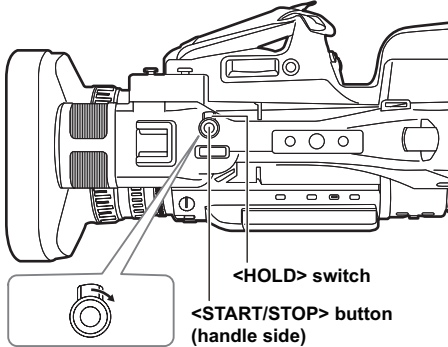

Turn clockwise to lock.

- When you press the <REC CHECK> button, images are not played back in right and left flipped state.
- Operation status displays when shooting a self-portrait
No display: You cannot record (no memory card, etc.)
[O]: Shooting in progress, during transition to shooting pause
[[]]: Shooting paused (shooting standby)
[!]: Warning display in progress
- Only part of the screen is displayed. When [!] appears, rotate the LCD monitor to the normal shooting orientation, and check the message content.
- When checking screen display information with the viewfinder, rotate the LCD monitor to the normal shooting orientation.
- Images that are the same as normal shooting are output to external devices.

Self-portrait recording

Open the LCD monitor, rotate it 180° to the lens side to record yourself. Selecting [MIRROR] in the [SELF SHOOT] item on the setup menu [DISPLAY SETUP] screen displays left and right flipped images so that you can shoot yourself like looking in the mirror. However, even though shooting in mirror mode, the recorded images are the same as normal shooting. Images are not recorded as mirrored images.

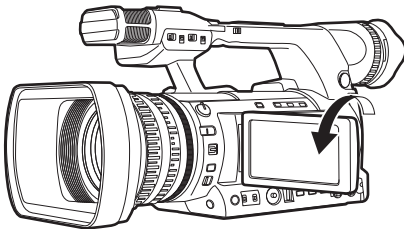

Zebra patterns

When you press the <ZEBRA> button while in <CAMERA> mode, a zebra pattern or marker is displayed on the viewfinder and LCD monitor, so you can check brightness of the subject.

Portions where over exposure might cause white out are displayed in a striped pattern.

- Extremely bright area
- Reflecting area

When you adjust iris and shutter speed in manual mode so that the zebra pattern disappears, you get images with less white out.

Every time you press the <ZEBRA> button, the display switches as follows.

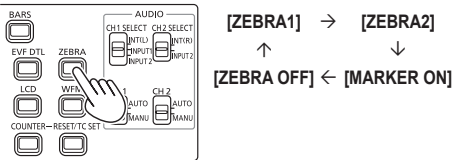

You can set the level of the zebra pattern with the [ZEBRA DETECT1] item and the [ZEBRA DETECT2] item on the setup menu [DISPLAY SETUP] screen. (Page 89)

Also when you set the [ZEBRA DETECT2] item to [OFF], even though you press the <ZEBRA> button, [ZEBRA2] will not be displayed.

The set zebra pattern is displayed for a fixed time (approximately 2 seconds) as [%].

Marker

If the [Y GET MARKER] item on the setup menu [DISPLAY SETUP] screen is set to [ON], press the <ZEBRA> button and set [MARKER ON] (Page 25), to display the marker in the center of the screen.

You can check brightness near screen center as a number ([0%]-[99%]).

When brightness exceeds [99%], [99%↑] is displayed.

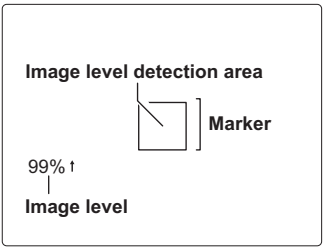

Press the <ZEBRA> button again to return to the normal screen.

Checking and displaying shooting status

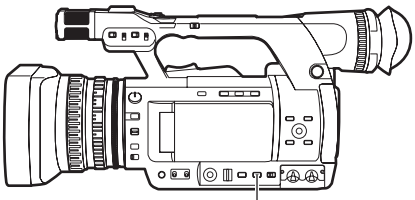

<DISP/MODE CHK> button

Hold down the <DISP/MODE CHK> button during shooting standby or shooting to display all information items including the setting status of various shooting functions, and list of functions assigned to the USER buttons, etc. Release the button to return to the normal display.

Press the <DISP/MODE CHK> button during shooting standby or shooting to hide all displays other than operation status display, frame display such as area, counter, marker, and safety zone display. Press the button again to return to the normal display. (Page 78)

This setting will be maintained even if the power of the camera is turned off by turning the POWER/MODE switch <OFF> or if the operation mode is changed.

In addition, press the <DISP/MODE CHK> button while the thumbnail screen is displayed in <PB> mode to display the properties of the selected clip. (Page 60) (Clips can be selected by moving the cursor with the OPERATION lever.)

Shooting using the <FUNCTION> knob

The following types of shooting can be carried out using the <FUNCTION> knob.

- Area auto focus function
Operates auto focus within an area frame selected using the <FUNCTION> knob.
- Area auto iris function
Automatically adjusts the iris value within an area frame selected using the <FUNCTION> knob. This function cannot be set when the [FACE DETECT] function has been set.
- Area luminance display
Displays an averaged luminance level within an area frame selected using the <FUNCTION> knob.

1 Select a function in the [FUNCTION KNOB] item on the setup menu [SW MODE] screen (Page 82).

[INH]: No function is assigned.

[FOCUS]: Area focus function and area focus bar function (during <MENU> setting)

[IRIS]: Area iris function and area iris meter function (during <MENU> setting)

[Y GET]: Area luminance display

[FOCUS/IRIS]:

Simultaneous operation of the area focus function and area iris function, simultaneous operation of the area focus bar function/ area iris meter function (during <MENU> setting)

[FOCUS/Y GET]:

Simultaneous operation of area focus function and area luminance display, simultaneous operation of area focus bar function (during <MENU> setting)

2 Press the <FUNCTION> knob.

- A white frame is displayed.
- There is no change in the operation of the camera other than the display of the frame.

3 Press the <FUNCTION> knob again.

- The white frame turns yellow.
- When the frame is yellow, the <FUNCTION> knob function set via the <MENU> operates in the area inside the frame.
- Pressing the <FUNCTION> knob once more returns the yellow frame to the white frame.

- Switching AUTO/MANUAL for [FOCUS/IRIS] is normally carried out in the same way.
- The central luminance function does not operate when the area luminance display is operating.
- If the <FUNCTION> knob is held down for more than two seconds, the frame disappears and the area function is switched off.

4 Move the <FUNCTION> knob up and down, and right and left.

- The white frame changes position. Move the frame to the area you wish to select.
- Press the <FUNCTION> knob.

-
- The area function does not operate during face detection.
 - The area function is released when the power switch is set to OFF or when the camera is switched to playback mode.
-



Optical image stabilizer function

When shooting with the camera hand held, you can reduce camera shake by using the optical image stabilizer function.

The optical image stabilizer can be switched ON/OFF with the <OIS> button.  is displayed in the viewfinder and the LCD monitor when the optical image stabilizer is ON. When using a tripod, natural images can be obtained by turning the optical image stabilizer function OFF.

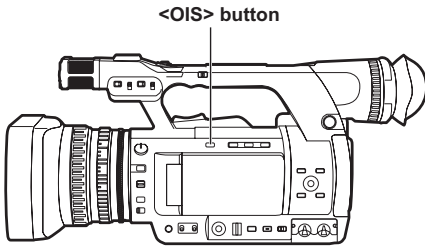

- When tracking a moving subject or there is a lot of camera shake, stabilization may not work.

Adding effects to images

Effects can be added to images by pressing the USER buttons assigned the [BLACKFADE] function and the [WHITEFADE] function. The buttons are forcibly disabled during playback, REC CHECK, and thumbnail display.

[BLACKFADE]:

Press the button to fade out to black. At this time audio fades out in the same way. Also, continue to press the button and the image fades out, release the button and it fades in.

[WHITEFADE]:

Press the button to fade out to white. At this time audio fades out in the same way. Also, continue to press the button and the image fades out, release the button and it fades in.

Using USER buttons

You can assign a single function from among 16 types of functions to each USER button. Use these buttons to change shooting conditions quickly or add the fade effect to images to match the subject.

In the factory settings, the following functions are assigned to each of the buttons.

- <USER1>: [BACKLIGHT]
- <USER2>: [D.ZOOM]
- <USER3>: [SHOT MARK]

For details, see the [USER1] - [USER3] items on the setup menu [SW MODE] screen (Page 83). If you press a USER button to which one of the functions has been assigned, and then turn OFF the power or change the mode during operation of the USER button function, it will return to the previous state.

Backlight compensation

When shooting subjects in backlight, press the USER button to which the [BACKLIGHT] function has been assigned.

[BACKLIGHT] will be displayed on the screen. Auto iris control for backlight compensation will prevent the image of the subject from becoming dark.

Press the USER button again to release backlight compensation. (In the manual iris mode, the iris status is retained at the corresponding point even when backlight compensation is canceled.)

Color bars

When in <CAMERA> mode, press the <BARS> button to display color bars, which are convenient for adjusting the picture quality of television and external monitors. Press again to return to the previous image.

- While color bars are displayed, a 1 kHz test tone is output from the headphone terminal or the <AUDIO OUT> terminal. It is not output from speakers.
- You can set test tone output with the [TEST TONE] item on the [AV OUT SETUP] screen.
- Press the <START/STOP> button to record color bars.
- The color bar display is released when power is switched off.
- When in <PB> mode, the <BARS> button is disabled.

Changing the image size

When recording in DV mode, the size of the images to record (aspect ratio) can be changed. Select in the [ASPECT CONV] item on the setup menu [RECORDING SETUP] screen.

[SIDE CROP]:

Recording is performed in standard 4:3 mode. Crops the left and right edges.

- When set to [SIDE CROP], information displayed in the black band portion on the left and right of the LCD and viewfinder is not displayed in external output.

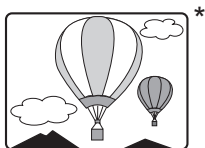

[LETTER BOX]:

Recording is performed in 16:9 angular field. The black band at the top and bottom of the screen is recorded.

- When set to [LETTER BOX], images are displayed in a 16:9 aspect ratio and [LT.BOX] is displayed on the LCD and viewfinder.



[SQUEEZE]:

The camera image is recorded compressed in the horizontal direction.

When recorded images are played on a wide screen supported TV monitor, they are displayed in a 16:9 aspect ratio.

- When set to [SQUEEZE], images are displayed in a 16:9 aspect ratio on the LCD and viewfinder.



- * The illustration is an image figure when external output is displayed on a 4:3 monitor screen.

Wave form monitor function

When in <CAMERA> mode, press the <WFM> button to display the wave forms of the images on the LCD monitor.

Press the button again to return to the normal display.

- Switching the wave form display, vector display, and wave/vector display is possible in the [WFM] item on the setup menu [SW MODE] screen (Page 83).
- Wave forms are not displayed on the viewfinder.
- Wave forms cannot be recorded.
- While wave forms are displayed, use the viewfinder as well because a part of the shooting screen and screen display will be hidden by wave forms.

Volume adjustment during shooting

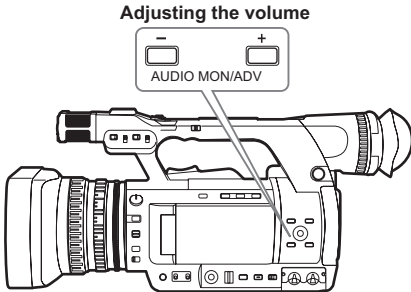

When monitoring sound with headphones while shooting, volume can be adjusted with the <AUDIO MON/ADV> button.

- Adjusting the input sound level (Page 39).
- The adjusted sound level is remembered when power is switched off by turning the POWER/MODE switch <OFF>.

Shot mark function

The mark attached to the thumbnails of clips is called a shot mark. On the thumbnail screen, only clips with shot marks attached can be selected and displayed/played back.

During shooting, when the USER button assigned to the [SHOT MARK] function is pressed, [MARK ON] is displayed on the LCD monitor and the viewfinder, and a shot mark is set on the thumbnail of the clip being shot. Press the button again to release it.

Also, shot marks can be set/released by performed the thumbnail operations of the clips. (Page 53) However, shot marks cannot be set/released while playing back.

- When shotmarks cannot be set/released, [INVALID] is displayed.

Index recording (AVCHD mode only)

This is a function that adds indexes to image points in a clip while shooting or playing back.

When the USER button assigned to the [INDEX] function is pressed during shooting, an index signal is recorded at that point. (Page 83)

It is also possible to add indexes during playback, or to display/play back only clips with indexes.

(Page 56)

- A maximum 100 indexes can be recorded to a single clip.
- When exceeding 100 indexes, even though the attachment operation is performed, [INVALID] is displayed and an index cannot be added.
- When continuously adding indexes, do so at intervals of one second or more. Even if the operation is performed continuously within one second, only the first operation will be valid.

[LAST CLIP] function

When [LAST CLIP] is assigned to a USER button, the last recorded clip can be deleted by pressing the button.

When the USER button assigned to [LAST CLIP] is pressed, [YES]/[NO] is displayed on the screen.

Select [YES] to delete the last recorded clip.

- Select [NO] not to delete the clip.
- You cannot delete clips if the following operations are performed after shooting.
 - When switched to <PB> mode
 - When changing the recording format
 - When connecting to a computer using a USB cable
 - When powering off the camera
 - When opening the memory card slot cover
- When in SIMUL REC mode the function does not operate.

Using special functions for recording

Pre-rec (PRE REC)

Video and audio are recorded from three seconds prior to the time of the operation to start recording.

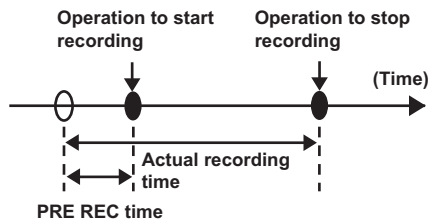

1 Set the [PREREC MODE] item on the setup menu [RECORDING SETUP] screen to [ON].

[PRE-REC] will be displayed on the screen.

- When the [TCG] item on the [TC/UB SETUP] screen has been set to [REC RUN], the setting will be automatically changed to [FREE RUN].

2 Press the <START/STOP> button.

Video and audio from approximately three seconds prior will be recorded.

- In the following cases recording of the previous three seconds of video and audio may not be possible even if recording is started immediately.
 - Immediately after switching from <PB> mode to <CAMERA> mode
 - Immediately after turning on the power
 - Immediately after changing the [PREREC MODE] item
- In AVCHD mode, the thumbnail for a clip shot using the pre-rec function will display the image at the time when the <START/STOP> button was pressed. In DV mode, it displays the image three seconds prior to the time when the <START/STOP> button is pressed.

INTERVAL REC (AVCHD mode only)

This function allows you to create short videos of scenes that move slowly over long periods of time through frame-by-frame recording at specified intervals.

One frame is recorded in each recording time period that has been set, and 24 frames form a one-second video.

You can specify the interval in <CAMERA> mode with the [INTERVAL REC] item in the setting menu [RECORD SETUP] screen.

- [1SECOND]/[10SECONDS]/[30SECONDS]/[1MINUTE]/[2MINUTES]: Changes the INTERVAL REC setting.

[OFF]: Does not set the INTERVAL REC.

- [↔] appears on the display.
- INTERVAL REC setting will be released when shooting is finished.
- Audio recording is disabled.
- If the PRE-REC function is set, the INTERVAL REC setting will be released.

Example	Recording interval	Shooting time	Video length
Sunsets	1 SECOND	30 min to 1 hr	1 min 15 sec to 2 min 30 sec
Butterfly emerging from cocoon	10 SECONDS	2 hr to 4 hr	30 sec to 1 min
Flowers blooming	30 SECONDS	1 hr to 3 hr	5 sec to 15 sec

- The maximum shooting time is 168 hours.
 - When recording for long periods, use the AC adaptor.
-
- Do not remove the battery or disconnect the AC adaptor during INTERVAL REC. Doing so may damage recorded image data or result in data loss.
 - You cannot change the recording mode while INTERVAL REC is enabled.
 - Depending on lighting and shooting conditions, color and focus settings may not be adjusted automatically. In such cases, make adjustments manually.
 - When INTERVAL REC is enabled, set the following recording format. If a different recording format is set, [INTERVAL REC] item is grayed out and cannot be enabled. Recording format: PH mode, 1080/24P
 - When playing back a recorded video, set the playback format to 1080/24P.
 - Even if the images have not met 24 frames when you stop recording, a one-second video will be created.
-

Time stamp function

The date and time of recording can be recorded to video images.

Select [ON] in the [TIME STAMP] item on the settings menu [RECORD SETUP] screen.

When the TIME STAMP function is [ON], [R] will be displayed in front of the date and time display in the viewfinder and the LCD monitor. In addition, the month display will change from a numerical value to an English name display.

- [R] display itself will not be recorded to the video.
- The size and position of the time and date characters recorded to the image will vary depending on the recording format.
- The size and position of the time stamp characters in external output displays may vary from the displays in the LCD monitor or viewfinder.
- The recorded time and date display will follow the settings made in the [DATE/TIME] item on the [DISPLAY SETUP] screen. If this item is set to [OFF], the date and time will not be recorded as a time stamp.
- To avoid date and time displays overlapping when clips with timestamps recorded are played with this camera, set the [DATE/TIME] item on the [DISPLAY SETUP] screen to [OFF]. You can also hide the date and time display by pressing the <DISP/MODE CHK> button.

Relay function

When the remaining space on a memory card is insufficient during recording, recording can be continued using the memory card in the other slot.

Set the [RELAY REC] item on the setup menu [RECORDING SETUP] screen to [ON].

- When the remaining space on a memory card is insufficient during recording, recording will automatically be continued using the memory card in the other slot.
- Relay recording is not available when a recordable memory card is not inserted in the memory card slot.
- The camera is capable of continuous recording for up to 12 hours maximum. This cannot be extended even if the relay function is used.

SIMUL REC

When memory cards are inserted in both of the two slots, activating this function enables recording the same video to both the memory cards. Set the [SIMUL REC] item on the setup menu [RECORDING SETUP] screen to [ON] to enter the SIMUL REC mode.

In the media capacity display on the screen, the available recording time possible for SIMUL REC (the available recording time of the memory card with lower memory capacity) is displayed, and the icon  is displayed.

- Recording stops when one of the memory cards in Slot 1 or Slot 2 has no remaining space.
(The following figure shows the case that the memory card in Slot 1 becomes full.)

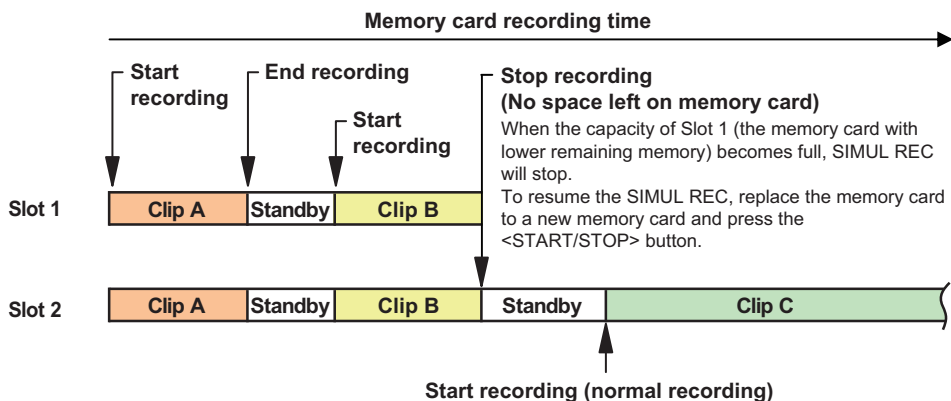

If you press the <START/STOP> button without replacing the memory card in Slot 1, video will be recorded normally on the memory card in Slot 2 (the memory card with remaining memory).

- SIMUL REC cannot be used at the same time as relay recording or INTERVAL REC.
- During SIMUL REC, if recording has stopped because a recording error has occurred in one of the memory cards, the other memory card will continue to record.
- After SIMUL REC ends, when there is capacity remaining on one of the memory cards, that memory card will automatically be selected as the memory card for recording. Press the <START/STOP> button again for normal recording.
- While in SIMUL REC mode, if only one memory card is inserted, normal recording takes place.
- After SIMUL REC, the REC CHECK function does not operate.
- After SIMUL REC, the [LAST CLIP] function does not operate.
- When switching to <PB> mode after SIMUL REC, the thumbnails of the memory card in slot 1 will be displayed.

Backup recording (DV mode only)

The video recorded with this camera can be saved and automatically backed up in an external device connected using the <DV OUT> terminal on the camera.

Set the control method of the external device in the [DV CONTROL] and [DV CMD SEL] items of the setting menu [OTHER FUNCTIONS] screen. (Pages 93, 94)

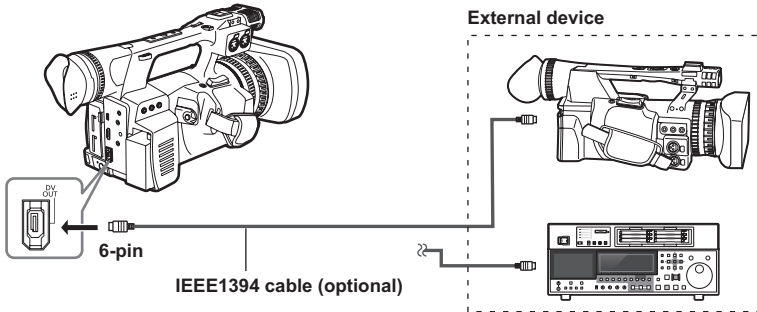

When you use backup recording function, be careful about the following:

- After performing backup recording, check the setting of menu items before operating the camera. Since the setting of menu items remain even after turning off the power, using the camera with the backup function set may cause overwriting to the media in the external device.
- Backup recording may not work properly if two or more external devices are connected.
- Use an IEEE1394 cable that is 4.5 m or shorter.
- When performing backup recording, set the external device so that it records 1394 signals.
- If you perform backup recording with [CHAIN] in the [DV CONTROL] item (Page 93) of the setting menu [OTHER FUNCTIONS] screen set to on, when the memory of the memory card becomes nearly full, the backup device which has been on standby will automatically start recording.
- Note that if you perform REC CHECK, the checked video will be recorded.
- When connecting and disconnecting an IEEE1394 cable, be sure to turn off the power of the device to be connected.
- When connecting an external device equipped with a 4-pin type IEEE1394 terminal, connect the <DV OUT> terminal (6-pin) first.
- Use a double-shielded IEEE1394 cable.

Adjusting the shutter speed

Using the <SHTR> dial

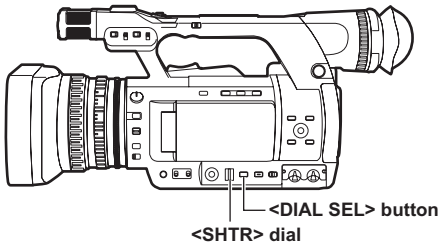

1 Press the <DIAL SEL> button.

- The role of the <SHTR> dial changes in the following order.
[DIAL SHUTTER]→[DIAL SYNCHRO SCAN]→[DIAL LOCK]
- To select [DIAL SYNCHRO SCAN], press the <DIAL SEL> button and select [DIAL SHUTTER], and turn the <SHTR> dial to set the synchro scan.

-
- After approximately 12 seconds without a dial operation, [DIAL LOCK] will be set automatically. To operate the camera again, press the <DIAL SEL> button. The camera resumes the last operated mode. You can also use the <DIAL SEL> button to set [DIAL LOCK] in order to prevent unintentional operation.
-

Setting the shutter

1 Press the <DIAL SEL> button and select [DIAL SHUTTER].

2 Press the <SHTR> dial.

- Each time the <SHTR> dial is pressed, the shutter will turn ON/OFF.
- The shutter speed is changed in the order shown in the charts on page 35 by turning the <SHTR> dial when the shutter is ON.

-
- Remember that the faster the shutter speed, the lower the camera sensitivity.
 - Focusing on the subject would take longer if the shutter speed is reduced, it is therefore recommended that the camera be secured to a tripod, etc. during shooting.
 - Under the lighting of electric discharge tubes such as fluorescent lamps, horizontal bands may appear on the screen. Adjusting the shutter speed may improve this condition.
 - A subject that quickly crosses the camera may appear distorted when shot. This is due to the signal reading system of the pickup devices (MOS sensor), and is not a defect.
 - At slow shutter speeds (1/6 to 1/15), white, red, green, or blue dots may appear on the screen, however, this is not a defect.
-

Setting the synchro scan

- 1** Press the <DIAL SEL> button and select [DIAL SHUTTER].
- 2** Turn the <SHTR> dial and set the synchro scan.
- 3** Press the <DIAL SEL> button and select [DIAL SYNCHRO SCAN].
- 4** Turn the <SHTR> dial.
 - The [SYNCHRO SCAN] shutter speed can be set.
 - The shutter speed changes quickly when turning the <SHTR> dial while holding it down.
 - Synchro scan can also be set with the [SYNCHRO SCAN] item on the setup menu [SCENE FILE] screen.

-
- The setting format can be changed with the [SYNC SCAN TYPE] item on the setup menu [SCENE FILE] screen.
[deg.]: angle display (180.0 d etc.)
[sec]: speed display (1/48.0 etc.)
-

When 1080/60i, 720/60P, 480/60i	
Normal (OFF) 1/60	[SYNCHRO SCAN] ↔ 1/8 ↔ 1/15 ↔ 1/30 ↔ 1/100 ↓ ↑ 1/2000 ↔ 1/1000 ↔ 1/500 ↔ 1/250 ↔ 1/120
When 1080/30P, 720/30P, 480/30P	
Normal (OFF) 1/50	[SYNCHRO SCAN] ↔ 1/8 ↔ 1/15 ↔ 1/30 ↔ 1/60 ↓ ↑ 1/2000 ↔ 1/1000 ↔ 1/500 ↔ 1/250 ↔ 1/120
When 1080/24P, 720/24P, 480/24P	
Normal (OFF) 1/50	[SYNCHRO SCAN] ↔ 1/6 ↔ 1/12 ↔ 1/24 ↔ 1/60 ↓ ↑ 1/2000 ↔ 1/1000 ↔ 1/500 ↔ 1/250 ↔ 1/120

Synchro scan

The synchro scan shutter speed used when the shooting screens such as a television screen or computer monitor is set using the <SHTR> dial (Page 34), or the [SYNCHRO SCAN] item on the setup menu [SCENE FILE] screen. (Page 79)

- Adjust the shutter speed to match the frequency of the television or computer monitor to minimize the horizontal noise that appears when shooting such subjects.
- By switching to progressive mode, you can also shoot the PAL system television screens.
- If the set value of the [SYNCHRO SCAN] item on the setup menu [SCENE FILE] screen is displayed in gray, it cannot be used with the current recording format. This function will only operate for preset values for each recording format.

The preset values for each recording format are as follows. ([SYNC SCAN TYPE] = [sec])

60i/60P mode: 1/60 second

30P mode: 1/30 second

24P mode: 1/24 second

-
-
- You can change the progressive mode with the [REC FORMAT] item on the setup menu [RECORDING SETUP] screen. (Page 85)
-
-

Changing audio input

When shooting, a maximum of two channels of audio can be recorded. Also, audio input to be recorded in each channel can be switched to built-in microphone, external microphone, or connected audio devices.

AUDIO CH1 SELECT switch

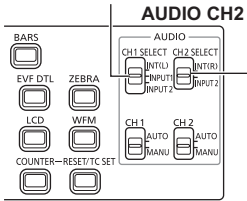

AUDIO CH2 SELECT switch

Using the built-in microphone

- 1 Set the AUDIO CH1 SELECT switch to <INT (L)>.**
 - Audio from the built-in microphone Lch is recorded to audio channel 1.
- 2 Set the AUDIO CH2 SELECT switch to <INT (R)>.**
 - Audio from the built-in microphone Rch is recorded to audio channel 2.

Using an external microphone and audio devices

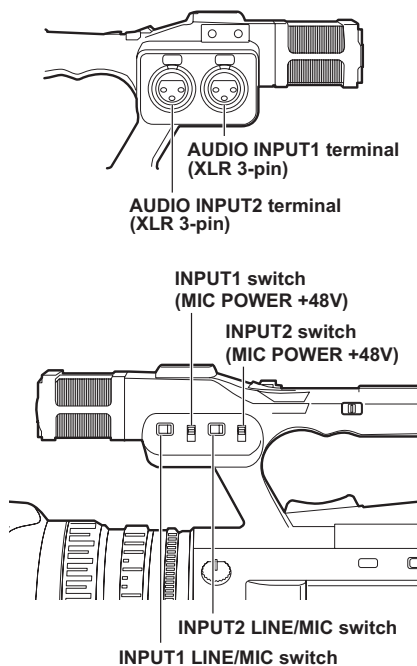

1 Connect an external microphone or audio device to the AUDIO INPUT1/2 terminals (XLR 3-pin). (Page 63)

2 Switch the connected audio input signal with the INPUT1 LINE/MIC switch or INPUT2 LINE/MIC switch.

<LINE>: (When connecting audio device)

The input level is 0 dBu.

<MIC>: (When connecting an external microphone)

The factory setting for input level is -50 dBu. The input level can be changed to [-40dB] or [-60dB] with the [MIC GAIN1] item and [MIC GAIN2] item on the setup menu [RECORDING SETUP] screen. (Page 86) However, sensitivity will be higher when set to [-60dB], and more noise may be recorded.

3 When using the phantom microphone (which requires +48V power supply)

Set the INPUT1 switch (MIC POWER+48V) and INPUT2 switch (MIC POWER+48V) to <ON>.

<ON>: (When connecting the phantom microphone)

+48V power is supplied to AUDIO INPUT1/2 terminals.

<OFF>: (When not connecting the phantom microphone)

+48V power is not supplied to AUDIO INPUT1/2 terminals.

- When you use a phantom microphone, the battery duration will become shorter.
- When devices that do not support +48V power supply are connected, set the phantom microphone to <OFF>. If set to <ON>, the connected devices might be damaged.
- When using the AG-MC200G (optional), set the [MIC GAIN1] or [MIC GAIN2] item of the [RECORDING SETUP] screen to [-50dB].

4 Use the AUDIO CH1 SELECT switch to select the input signal to be recorded to audio channel 1.

<INT (L)>:

Audio from the built-in microphone Lch is recorded.

<INPUT1>:

Audio from the device connected to AUDIO INPUT1 terminal is recorded.

<INPUT2>:

Audio from the device connected to AUDIO INPUT2 terminal is recorded.

5 Use the AUDIO CH2 SELECT switch to select the input signal to be recorded to audio channel 2.

<INT (R)>:

Audio from the built-in microphone Rch is recorded.

<INPUT2>:

Audio from the device connected to AUDIO INPUT2 terminal is recorded.

• Audio input switching

Switch setting		Recording channel	
AUDIO CH1 SELECT switch	AUDIO CH2 SELECT switch	CH1	CH2
INT(L)	INT(R)	Built-in microphone Lch	Built-in microphone Rch
	INPUT2	Built-in microphone Lch	INPUT2
INPUT1	INT(R)	INPUT1	Built-in microphone Rch
	INPUT2	INPUT1	INPUT2
INPUT2	INT(R)	INPUT2	Built-in microphone Rch
	INPUT2	INPUT2	INPUT2

- When inputting an external microphone signal to CH1 and CH2, connect the microphone to the AUDIO INPUT2 terminal, and set both the AUDIO CH1 SELECT switch and AUDIO CH2 SELECT switch to INPUT2.

- Since the audio signal recording level is adjusted automatically, the zoom operation sound may be recorded if zooming quickly, depending on the environment.

Adjusting the audio recording level manually

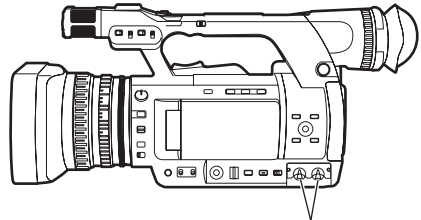

<AUDIO LEVEL> knob

1 Set the AUDIO AUTO/MANU CH1 or CH2 switch to <MANU> position.

Adjust the audio signal recording level input through the built-in microphone and the AUDIO INPUT1/2 terminals (XLR 3-pin) using <AUDIO LEVEL> knob. Check the audio level meter display on the bottom left of the LCD monitor or viewfinder.

- CH1/CH2 can be set separately.
- When <MANU> is set, the setting in the [AUDIO LIMITER CH1]/[AUDIO LIMITER CH2] item of the setup menu [RECORDING SETUP] (Page 86) is enabled.



Adjusting the audio recording level automatically

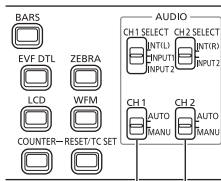

AUDIO AUTO/MANU CH1 switch

AUDIO AUTO/MANU CH2 switch

1 Set the AUDIO AUTO/MANU CH1 or CH2 switch to <AUTO> position.

Adjust the audio signal recording level input through the built-in microphone and the AUDIO INPUT1/2 terminals (XLR 3-pin) automatically.

- CH1/CH2 can be set separately.
- When <AUTO> is set, the recording level adjustment using the <AUDIO LEVEL> knob and the setting in the [AUDIO LIMITER CH1]/[AUDIO LIMITER CH2] item of the setup menu [RECORDING SETUP] screen (Page 86) are disabled.

- Before shooting, check the recording volume level.
- When recording, the recording level of this camera is set approximately 8 dB higher than Panasonic shoulder camera-recorders for broadcast.

Using shooting settings (scene files)

Settings according to a variety of shooting conditions are stored in the positions on the <SCENE FILE> dial (<F1> to <F6>). When shooting, you can use the <SCENE FILE> dial to immediately read out required files.

- The following files are stored as factory settings.

<F1>: [SCENE]

File suitable for normal shooting.

<F2>: [SCENE FLUO.]

File suitable for shooting under fluorescent lights (indoor shooting).

<F3>: [SCENE SPARK]

File suitable for shooting with fuller variations of resolution, coloring, and contrast.

<F4>: [SCENE B-STR]

File suitable for broadening the contrast of dark areas (such as shooting sunsets).

<F5>: [SCENE CINE V]

File suitable for shooting movie-like scenes where contrast is emphasized. (Even when the scene file is changed, the recording format is unchanged. It must be set with the [REC FORMAT] item on the [RECORDING SETUP] screen. See page 85.)

<F6>: [SCENE CINE D]

File suitable for shooting movie-like scenes where dynamic range is emphasized. (Even when the scene file is changed, the recording format is unchanged. It must be set with the [REC FORMAT] item on the [RECORDING SETUP] screen. See page 85.)

Changing scene file settings

The setting value of a scene file can be changed. Also, changed scene files can be stored at each position of the <SCENE FILE> dial (<F1> to <F6>).

Example: Change the name of the scene file

- 1** Turn the **POWER/MODE** switch of the camera **<ON>**. (Page 27 of Vol.1)
- 2** Turn the **<SCENE FILE>** dial to select a scene file to change.
- 3** Select the setup menu **[SCENE FILE]** screen.
 - Menu operation (Page 28 of Vol.1)
 - Operations can be performed with buttons on the remote control that correspond to those on the camera. For details, see "Remote control" (Page 21 of Vol.1).
- 4** Tilt the **OPERATION** lever in the **<▲><▼>** directions to select the **[NAME EDIT]** item.
- 5** Push the **OPERATION** lever (or tilt in the **<▶>** direction) and tilt in the **<▲>** direction to select **[YES]**, then push the **OPERATION** lever again.

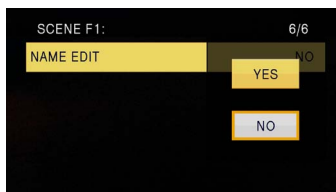

6 When the following screen is displayed, use the **OPERATION** lever to set a six-character file name.

Perform this using the same method as setting user information (Page 49).

- Characters that can be set (Space), A-Z, 0-9, :< = > ? @ [] ^ _ - . /
- When setting the file name, press the <RESET/TC SET> button to clear the characters.



7 When finished setting the file name, push the **OPERATION** lever.

8 Select **[YES]** on the confirmation screen.

- When you select [YES], you will exit the [NAME EDIT] screen and the setting change completes.
- Once the setting change has been completed, the changed name and values are stored and they remain after turning off the power or changing the scene dials.

Storing scene files and other settings on memory cards

You can save up to four scene file settings or other settings as files on a memory card, and you can also load them from the memory card.

- In the case of the scene files, the current settings are automatically saved in the camera, and the saved data is written on a memory card. When the data has been read from a memory card, the current settings are rewritten at the same time as the data saved inside the camera.
- The data in all the scene files, <F1> to <F6> is rewritten.

The following description basically describes storing scene files.

- 1 Turn the POWER/MODE switch of the camera <ON>. (Page 27 of Vol.1)**
- 2 Select the slot number for the memory card onto which you wish to save from the [CARD WRITE] item on the setup menu [SCENE FILE] screen, and push the OPERATION lever.**

For other settings, select the [USER FILE] screen. (Page 92)

- Menu operation (Page 28 of Vol.1)
- Operations may be performed with buttons on the remote control that correspond to those on the camera. For details, see “Remote control” (Page 21 of Vol.1).

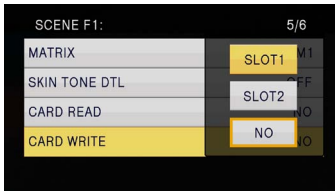

- 3 Tilt the OPERATION lever in the <<<>>> <>><>> directions, select a file, and push the OPERATION lever to set the file name.**

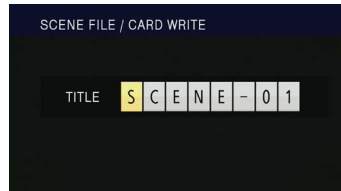
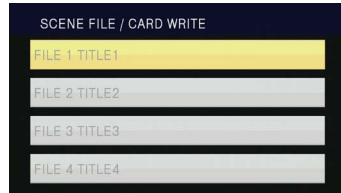

- 4 Push the OPERATION lever again, select [YES] when the following screen appears, and push the OPERATION lever.**
- In the following example, [SCENE-01] is the TITLE name. To change the TITLE name, see the following description.

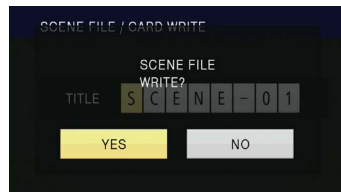

- “FILE 1 (file name) WRITE COMPLETED” is displayed when writing is complete.

5 Press the <MENU> button to release menu mode.

To read files

- 1) Select [CARD READ] in step **2** and push the OPERATION lever.
- 2) Select the file number, and push the OPERATION lever.
- 3) Select [YES] on the confirmation screen.
"FILE 1 (file name) READ COMPLETED" is displayed when reading is complete.

To add titles to files

- 1) Go through steps **1** to **3**.
- 2) Tilt the OPERATION lever in the <▲><▼> directions to select a character, and tilt in the <►> direction to move to the next character.
The following characters can be input.
(Space), A-Z, 0-9, : < = > ? @ [] ^ _ - . /
- 3) When all input is finished, push the OPERATION lever.
- 4) Press [YES] on the confirmation screen.

-
- If [WRITE PROTECT] appears, release the protected status of the memory card.
 - If "FILE 1 (file name) WRITE FAILED" appears, quit all other operations (such as playback) before proceeding.
-

Clip metadata (AVCHD mode only)

You can add the video and audio formats, name of the videographer, shooting location, text memos, and other information to the video data you have recorded on the memory card. This data is called the clip metadata. (For display method, see page 60.)

There are two types of clip metadata: the data that is recorded automatically during shooting, and the data in the metadata upload file created on the memory card which is loaded in the camera. (For the clip metadata loading method, see page 45.)

Content of clip metadata

You can set the items underlined by loading the metadata upload file on the memory card. Other items are set automatically during shooting.

[CLIP PROPERTY / GLOBAL CLIP ID]:

This indicates the global clip ID that shows the shooting status of the clip.

[CLIP PROPERTY / USER CLIP NAME]:

This indicates the name of the clip that the user has set.*1

[CLIP PROPERTY / VIDEO & AUDIO]:

This indicates the [FRAME RATE], [REC RATE], [RESOLUTION], [PULL DOWN] system and [AUDIO] (recording audio) of the recorded image.

[CLIP PROPERTY / ACCESS]:

This indicates the [CREATOR] (name of the person recording), [CREATION DATE] (recording date), [LAST UPDATE DATE] (date on which the data was last updated), and [LAST UPDATE PERSON] (the person who last updated the data).

[CLIP PROPERTY / DEVICE]:

This indicates the [MANUFACTURER] (manufacturer of the equipment), [SERIAL NO.] (serial number of the equipment) and [MODEL NAME] (equipment model name: AG-AC130 for this camera).

[CLIP PROPERTY / SHOOT]:

This indicates the [SHOOTER] (name of the videographer) and the [PLACE NAME] (name of shooting location).

[CLIP PROPERTY / LOCATION]:

This indicates [ALTITUDE], [LONGITUDE], [LATITUDE] of the shooting location, and [SOURCE] (information source). Not recorded in this camera.

[CLIP PROPERTY / SCENARIO]:*2

This indicates the [PROGRAM NAME], [SCENE NO.] (scene number), and [TAKE NO.] (take number).

[CLIP PROPERTY / NEWS 1]:

This indicates the [REPORTER] (name of the reporter), and [PURPOSE] (purpose of data collection).

[CLIP PROPERTY / NEWS 2]:

This indicates the [OBJECT] (target of data collection).

[CLIP PROPERTY / MEMO]:*3

This indicates the [PERSON] (name of the person who recorded the text memo), and [TEXT] (content of the text memo).

- *1 If there is no information in the metadata upload file, consecutive 5-digit numbers will be applied to the clips in the order that they were recorded, with the first clip to be recorded given the number 0. The recording method of [CLIP PROPERTY / USER CLIP NAME] is selectable. For details, see page 45.
- *2 When you input the [CLIP PROPERTY / SCENARIO], you must input the [PROGRAM NAME]. You cannot input [SCENE NO.], [TAKE NO.] only.
- *3 When you input a [CLIP PROPERTY / MEMO], you must input the [TEXT]. You cannot input [PERSON] only.

-
- This camera can only display ASCII characters.
 - Due to limitations imposed by the camera on the number of characters which can be displayed, not all the data can be displayed. (This does not mean that data which is not displayed has been deleted.) Use an AVCCAM viewer or other program to check all the data.
 - Metadata can be created with AVCCAM viewer. (Page 69)
-

Uploading metadata [META DATA]

You can perform the following operations.

If necessary make preparations.

- Loading metadata
 - Insert the memory card on which the metadata is recorded into the camera. (For details on clip metadata, see page 44.)
- Selecting whether to record the metadata on the memory card
- Initializing the metadata inside the camera
- Displaying the metadata inside the camera

- 1 Turn the **POWER/MODE** switch to go into **<CAMERA>** mode.
- 2 Press the **<MENU>** button.
Menu operation (Page 28 of Vol.1)
- 3 Tilt the **OPERATION** lever in the **<▲><▼>** directions to select **[META DATA]**, and push the **OPERATION** lever (or tilt in the **<▶>** direction).

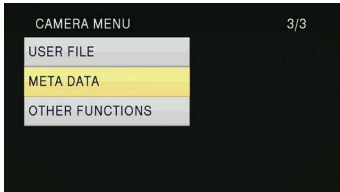

- 4 Tilt the **OPERATION** lever in the **<▲><▼>** directions to select items, and push the **OPERATION** lever.

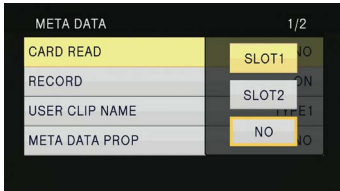

[CARD READ]:

Loads the metadata set on the memory card on to the camera.

Move to [CARD READ], push the **OPERATION** lever, select either [SLOT1]/[SLOT2]/[NO], and push the **OPERATION** lever.

- Up to eight items of metadata on the memory card can be displayed, starting from the most recent creation date.
- If characters other than single-byte alphanumeric characters are used in the metadata file to be loaded they are displayed as “*”.

[RECORD]:

Sets whether to record the metadata loaded on the camera simultaneously on a memory card when recording.

Select either [ON]/[OFF] (format/do not format), and push the **OPERATION** lever.

The factory setting for this mode is [OFF].

[USER CLIP NAME]:

The [USER CLIP NAME] recording method is selectable. For details, see the next column.

[META DATA PROP]:

Displays the metadata recorded in the camera.

[CLIP COUNTER RST]:

Resets the counter value to 1.

Select either [YES]/[NO] (reset/do not reset), and push the **OPERATION** lever.

[META INIT SET]:

Initializes the metadata recorded in the camera.

Select either [YES]/[NO] (initialize/do not initialize), and push the **OPERATION** lever.

- 5 Press the **<MENU>** button to release menu mode.

Selecting the [USER CLIP NAME] recording method

Press the **<MENU>** button and select [META DATA]→[USER CLIP NAME] to select the [USER CLIP NAME] recording method. Two options are available: [TYPE1] and [TYPE2].

[USER CLIP NAME] to be recorded

	[TYPE1]	[TYPE2]
When clip metadata has been loaded	Uploaded data	Uploaded data + COUNT value*
When no clip metadata has been loaded, or when recording of loaded clip metadata has been disabled	Sequential 5-digit number in the order of shooting	Sequential 5-digit number in order of shooting

* The COUNT value is indicated as a 4-digit number. The COUNT value is incremented each time a new clip is shot when clip metadata has been loaded and the recording method has been set to [TYPE2]. The COUNT value can be reset with the following method. Press the <MENU> button, select [META DATA]→[CLIP COUNTER RST]→[YES], and push the OPERATION lever to reset the COUNT value to 1.

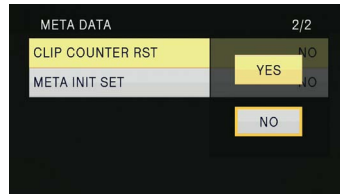

Using the counter

Counter display

You can display a counter that indicates how much time has elapsed during shooting or playback.

1 Press the <COUNTER> button.

Each time you press the button, the display changes as follows. (Page 71)

[0:00.00] (<CAMERA> mode only)

Counter value display. Displayed when [TOTAL]* is selected with the [REC COUNTER] item on the setup menu [DISPLAY SETUP] screen.

[CLIP 0:00.00]

Displayed when [CLIP]* is selected with the [REC COUNTER] item on the setup menu [DISPLAY SETUP] screen.

Values are automatically reset when shooting is started, and counter values are displayed for each individual clip.

* The count is not displayed in <PB> mode.

[TC 12:34:56.01]

Time code display (Displays the frame digits in 24 frames in PH1080/24P and PH720/24P modes. In 480i/24P mode, the frame digits are converted into 30 frames.)

[UB 12 34 56 78]

User information

No display:

Data is not displayed.

- To reset the counter value, press the <RESET/TC SET> button while the counter value is being displayed.

TC preset mode

Synchronizes the initial time code value during multi-camera shooting. (Hereafter, the camera used for synchronization is described as the MASTER and the camera being synchronized is described as the SLAVE.)

1 Connect the TC PRESET IN/OUT terminals (<VIDEO OUT> terminals) on the two devices with a pin cable, and turn on the power.

■ MASTER settings

2 Check that the MASTER camera is set to the <CAMERA> mode, and set the [EXT TC LINK] item on the setup menu [TC/UB SETUP] screen to [MASTER].

[OUTPUTTING LTC SIGNAL] is displayed on the screen, and the time code is output from the TC PRESET IN/OUT terminal (<VIDEO OUT> terminal).

- Select the same recording format for the MASTER and SLAVE cameras, and set the [TCG] item on the [TC/UB SETUP] screen to [FREE RUN].
- To cancel the time code output, press the <MENU> button.

■ SLAVE settings

3 Set the [EXT TC LINK] item on the setup menu [TC/UB SETUP] screen to [SLAVE].

4 Press the <COUNTER>-<RESET/TC SET> button. TCG values will be preset to the TC values input from the MASTER.

- The menu screen is closed and [TC LINK OK] is displayed in the center of the screen.
- If the TC values cannot be set correctly, [LINK NG] will be displayed.
- If the SLAVE camera is set to 24P, set the [TC MODE] item of the MASTER camera to [NDF].
- To cancel the [SLAVE] mode, press the <MENU> button.

Charging the built-in battery/setting the time code

Charging the built-in battery

The camera uses the built-in battery to remember the date and time.

If [LOW INTERNAL BATTERY] (built-in battery level is low) is displayed when the date and time are set, it means that the built-in battery is depleted. Charge the battery with the following method. Set the date and time after the battery fully charged.

1 Connect an AC adaptor to the camera.

(Page 24 of Vol.1)

- Leave the POWER/MODE switch of the camera at <OFF>.

2 Leave the camera for approximately four hours.

- The built-in battery is charged.
- Check the time code and menu operations after charging.

If the date and time are not remembered after charging, the built-in battery needs to be replaced. Consult your dealer.

Setting the time code

Perform various time code related settings with the following items on the setup menu [TC/UB SETUP] screen. (Page 87)

- [TC MODE] item
- [TCG] item
- [TC PRESET] item
- [UB MODE] item (DV mode only)

Specifying the time code ([TC PRESET] item)

Set the time code value with the [TC PRESET] item to record any value as the time code value at the start of recording.

1 Turn the POWER/MODE switch of the camera <ON>. (Page 27 of Vol.1)

2 Select the [TC PRESET] item on the setup menu [TC/UB SETUP] screen.

- Menu operation (Page 28 of Vol.1)
- Operations can be performed with buttons on the remote control that correspond to those on the camera. For details, see "Remote control" (Page 21 of Vol.1).

3 Tilt the OPERATION lever in the <Δ> direction to move to [YES], and push the OPERATION lever.

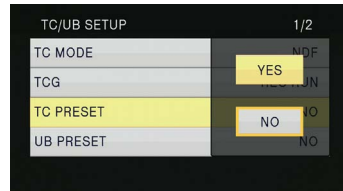

4 When the following screen appears, set the time code value.

Tilt the OPERATION lever in the <▲><▼> directions to select the time code value.



Tilt the OPERATION lever in the <▶> direction to move to the next digit, and tilt in the <▲><▼> directions again to select the value.



6 Tilt the OPERATION lever in the <◀> direction to move to [YES], and push the OPERATION lever.

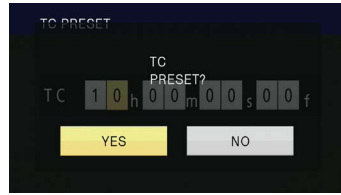

This camera adjusts the time code value in accordance with the format and frame rate. For this reason, bear in mind that making a change in the format or frame rate may result in discontinuity from the last time code value of the previous recording. Adjustments are made in increments in the following table when the recording format is 24P.

Recording format	Time code adjustment
1080/24P	4-frame increments
720/24P	
480/24P	5-frame increments

- You can reset the time code value to zero by pressing the <RESET/TC SET> button while setting the time code.

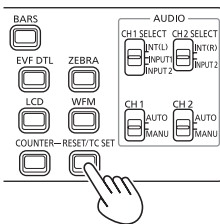

5 When finished setting the time code value, push the OPERATION lever.

Setting user information

Setting user information allows you to store 8-digit memo information in the hexadecimal format. User information is automatically saved in the memory and retained after you turn off the power.

In DV mode, [USER]/[TIME]/[DATE]/[TCG]/[FRAME RATE] can be selected with the [UB MODE] item on the setup menu [TC/UB SETUP] screen. Select [USER] to set user information in DV mode.

1 Turn the POWER/MODE switch of the camera <ON>. (Page 27 of Vol.1)

2 Select the [UB PRESET] item on the setup menu [TC/UB SETUP] screen.

- Menu operation (Page 28 of Vol.1)
- Operations can be performed with buttons on the remote control that correspond to those on the camera. For details, see “Remote control” (Page 21 of Vol.1).

3 Tilt the OPERATION lever in the <▲> direction to move to [YES], and push the OPERATION lever.



4 Set the user information.

Tilt the OPERATION lever in the <▲><▼> directions to select user information characters.

- You can set numbers from 0 to 9 and letters from A to F for the user information.

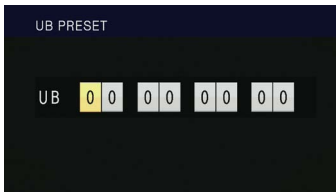

Tilt the OPERATION lever in the <◀> direction to move to the next digit, and tilt in the <▲><▼> directions again to select the character.



- You can reset the user information to zero by pressing the <RESET/TC SET> button while setting the user information.

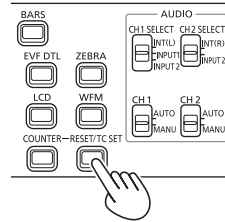

5 When finished setting the user information, push the OPERATION lever.

6 Tilt the OPERATION lever in the <◀> direction to move to [YES], and push the OPERATION lever.



Basic playback operations

Mode lamp

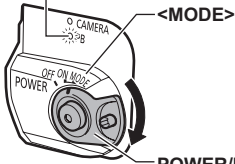

POWER/MODE switch

1 Turn the **POWER/MODE** switch to the **<MODE>** position to light the mode lamp **<PB>**.

The mode lamp **<PB>** is lit in green and the **<PB>** mode is enabled.

- Each time you turn the switch to the **<MODE>** position, the **<CAMERA>** mode and the **<PB>** mode switch.

For details on playing back clips using thumbnails, see page 51.

Operations using the Operation lever		Remote control
	Play <▶▶> Press to play the clip with the cursor position.	
	Fast forward <▶▶▶> Press during <u>playback</u> to scroll quickly (approx. 10 times the speed) through the clip. Repeat the operation to scroll more quickly (approx. 20 times the speed). Press <u>while pause</u> to move to the next clip.	
	Rewind <◀◀> Press <u>during playback</u> to scroll quickly backwards (approx. 10 times the speed) through the clip. Repeat the operation to scroll more quickly backwards (approx. 20 times the speed). Press <u>while pause</u> to move to the previous clip.	
	Stop <■>	
	Pause < > Press during playback to pause the clip. Press again to return to normal playback.	

■ In DV mode

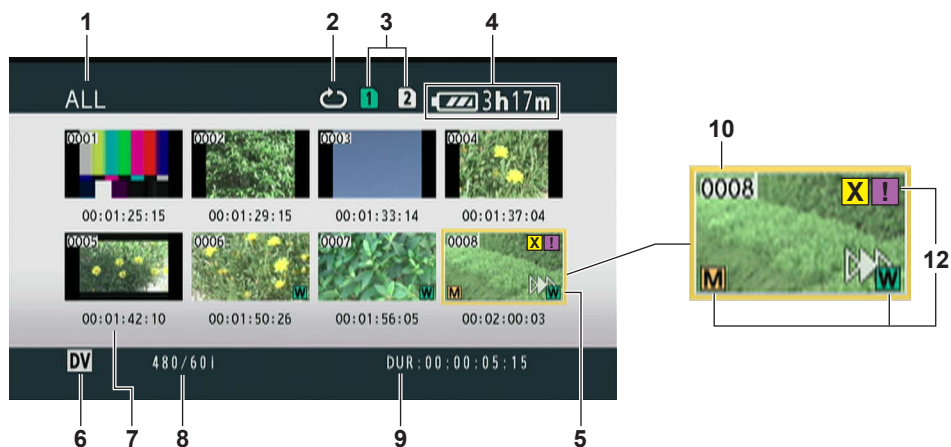

1 Thumbnail display status (Page 56)

The types of clips displayed as thumbnails appear in this area.

2 Repeat playback indicator (Page 54)

Displayed during repeat playback.

3 Media status display

Displays status of memory card.

4 Battery level display (Page 22 of Vol. 1)

Displays remaining battery level.

5 Cursor (Orange frame)

Displayed on currently selected thumbnail.

6 Recording mode display

Displays recording mode if the clip currently highlighted by the cursor has been shot in PH, PM, and DV modes. (Page 14)

7 Time display (Page 56)

Displays a time code at start of clip recording/ user information at start of clip recording/ shooting time/shooting date/shooting date and time - according to settings.

8 Recording format display

Displays recording format of the clip with the cursor position.

9 Duration display

Displays duration of the clip with the cursor position.

10 Clip number

Displayed in order of shooting. (Up to 1000 clips) Numbers of clips that cannot be played back (e.g. clips with different recording formats) are displayed in red.

To play clips displayed in red, set the [PB FORMAT] item in the setup menu [PLAY SETUP] screen to the appropriate recording format. (Page 95)

11 [On]: Clip protect display (AVCHD mode only)

Displayed on protected clips.

12 Indicators

- In AVCHD mode

[]: Shot mark

This indicates that a clip has a shot mark.

(Page 53)

[]: Index

This indicates that indexes have been added.

(Page 57)

[]: Resume playback display

Displayed on clips on which resume playback setting has been applied.

- In DV mode

[]: Shot mark

This indicates that a clip has a shot mark.

(Page 53)

[]: Wide

Displayed on clips recorded in 16:9 angular field.

[]: Resume playback display

Displayed on clips on which resume playback setting has been applied.

[] (Yellow): Defective clip (repairable clip)

Displayed on defective clips resulted from turning off the power during recording, etc. These may be repaired. (Page 58)

[] (Red): Defective clip (unrepairable clip)

Displayed on defective clips resulted from turning off the power during recording, etc. Delete these clips because they are not repairable. If you cannot delete these clips, format the memory card with this camera. (Page 13)

[]: Defective clip (clip with unknown content)

Displayed on clips with unknown content because the content is incompatible with this camera.

[]: Incomplete clip

When the recording capacity of one clip exceeds 4 GB (recording time is approximately 16 minutes), the clip is automatically split and saved as another clip. This is displayed on clips that were not saved successfully as associated clips due to power being switched off during recording, etc.

- To display CLIP PROPERTY on the thumbnail screen, move the cursor using the OPERATION lever to the clip you want to display properties for, and press the <DISP/MODE CHK> button. For details on display, see “Clip information screen” (Page 60). Press the <MENU> button while displaying the properties to return to the thumbnail screen.

Adding shot marks to clips

Adding shot marks  will make it easier to find the clips you are looking for.

- 1 Tilt the OPERATION lever in the <<◀>> <▲><▼> directions to move the cursor to the clip for which a shot mark is to be added.
- 2 Press the USER button to which the shot mark function has been allocated. (Page 83)
 - To release a shot mark, repeat the preceding steps.
 - It is not possible to add shot marks to clips shot using a consumer camcorder model.

Selecting the memory card slot for playback

You can switch the memory card slot for playback.

- 1 Press the <SLOT SEL> button when the thumbnail screen is displayed in the <PB> mode.

Playback settings [PLAY SETUP]

Make settings for playback format and method.

Setting playback format [PB FORMAT] (only in AVCHD mode)

Set format for playback.

- 1 Press the **<MENU>** button.
Menu operation (Page 28 of Vol. 1)
- 2 Select the **[PB FORMAT]** item in the **[PLAY SETUP]** screen, and push the **OPERATION** lever (or tilt in the **▶** direction).

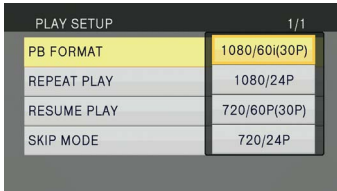

- 3 Tilt the **OPERATION** lever in the **<▲><▼>** directions to select the format for playback, and push the **OPERATION** lever.
 - The setting for the **[REC FORMAT]** item on the setup menu **[RECORDING SETUP]** screen is reflected as the initial setting.
 - Clip numbers will be displayed in black where playback is possible, and in red where playback is not possible.

-
- Even if the playback format is set, the recording format set in the **[REC FORMAT]** item on the setup menu **[RECORDING SETUP]** screen is restored when the camera is switched to **<CAMERA>** mode.
 - If the playback format does not conform to the clips created at the relay destination using the relay recording function, thumbnail images will not be displayed ([!] will be displayed). Thumbnail images will be displayed when the playback format is matched to the clips.
-

Repeat playback [REPEAT PLAY]

Use this setting to repeatedly play back all available clips on the selected slot.

- 1 Press the **<MENU>** button.
Menu operation (Page 28 of Vol. 1)
- 2 Set the **[REPEAT PLAY]** item in the **[PLAY SETUP]** screen to **[ON]**.
- 3 Press the **<MENU>** button to return to the thumbnail screen.
The repeat playback indicator will be displayed. When the playback operation is performed, the playable clips are played back repeatedly.
 - Repeat playback will continue until playback is paused.
 - To turn the repeat playback setting **[OFF]**, select **[OFF]** in step 2.

Resume playback [RESUME PLAY]

Use this setting to play back from where a clip had previously been paused.

- 1 Press the <MENU> button.**
Menu operation (Page 28 of Vol. 1)
- 2 Set the [RESUME PLAY] item in the [PLAY SETUP] screen to [ON].**
- 3 Press the <MENU> button to return to the thumbnail screen.**
- 4 Select a clip for playback.**
If playback has previously been paused, the resume playback indicator will be displayed on the clip thumbnail, and the remainder of the clip will be played the next time the clip is selected for playback.
 - To turn the resume playback setting [OFF], select [OFF] in step 2.
 - If you turn OFF the power or switch to <CAMERA> mode, the video position that was being played is canceled. (Playback will start from the beginning of the last clip.)

Setting the skip method [SKIP MODE] (only in AVCHD mode)

Select which skip (cue) operation is to be performed when playback is paused.

- 1 Press the <MENU> button.**
Menu operation (Page 28 of Vol. 1)
- 2 Select the [SKIP MODE] item in the [PLAY SETUP] screen.**
- 3 Select the skip method.**
[CLIP]:
Move to the beginning of the previous or next clip by tilting the OPERATION lever in the <◀> or <▶> direction while playback is paused.
[CLIP & INDEX]:
Move to the beginning of the previous or next clip, or to the previous or next INDEX position, by tilting the OPERATION lever in the <◀> or <▶> direction while playback is paused.
- 4 Press the <MENU> button to return to the thumbnail screen.**

Thumbnail operations

Selecting the thumbnail display method [THUMBNAIL]

You can display the kind of clips you want to see as thumbnails.

You can also set how you want the thumbnails to appear on the screen more precisely.

- 1 Press the <MENU> button.**
Menu operation (Page 28 of Vol. 1)
- 2 Select the [THUMBNAIL], and push the OPERATION lever (or tilt in the <>> direction).**
- 3 Tilt the OPERATION lever in the <▲><▼> directions to select items, and push the OPERATION lever.**

THUMBNAIL MODE	ALL
INDICATOR	SAME FORMAT
DATA DISPLAY	MARKER
DATE FORMAT	INDEX

[THUMBNAIL MODE]:

Select the clips to be displayed.

[ALL]:

Displays all clips.

[SAME FORMAT] (only in AVCHD mode):

Displays clips in the same format as the current PB format.

[MARKER]:

Displays all clips with shot marks.

[INDEX] (only in AVCHD mode):

Displays all clips with indexes.

[INDICATOR]:

Sets [ON]/[OFF] (display/hide) of indicator. (Factory setting is [ON].)

Clip protect display and resume playback display will still appear even if this setting is set to [OFF].

[DATA DISPLAY]:

Select format of clip time display - [TC] (time code)/[UB] (user information)/[TIME] (shooting time)/[DATE] (shooting date)/[DATE&TIME] (shooting date and time). If [DATE&TIME] is selected, the display will be in the format "Month-Day Time".

[DATE FORMAT]:

Select display order for shooting date - [Y/M/D] (Year-Month-Day)/[M/D/Y] (Month-Day-Year)/[D/M/Y] (Day-Month-Year).

This setting will not be reflected in CLIP PROPERTY.

- 4 Press the <MENU> button to return to the thumbnail screen.**

Deleting and protecting clips [OPERATION]

Clips may be deleted or protected (only in AVCHD mode).

1 Press the <MENU> button.

Menu operation (Page 28 of Vol. 1)

2 Select the [OPERATION], and push the OPERATION lever (or tilt in the <▶> direction).

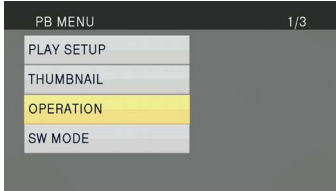

3 Tilt the OPERATION lever in the <▲><▼> directions to select items, and push the OPERATION lever.

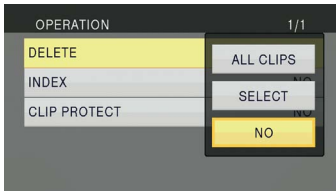

[DELETE]:

[ALL CLIPS]:

Deletes all clips.

Select [YES]/[NO] (delete/do not delete), and push the OPERATION lever.

[SELECT]:

Deletes selected clips.

If clips are selected with the OPERATION lever, the selected clips appear within a red frame. (Repeat this operation to select multiple clips.)

Press the <EXEC> button to confirm, tilt the OPERATION lever in the <◀><▶> directions to select [YES]/[NO] (delete/do not delete), and push the OPERATION lever.

[NO]:

Returns to the previous screen.

- Protected clips cannot be deleted.
- If selecting [ALL CLIPS] to delete all clips from the memory, this operation may take some time to complete, depending on the volume of clips to be deleted.
- Deletion cannot be performed via the remote control.
- To abort deletion, push the OPERATION lever while CANCEL is displayed on the screen. The already deleted clips cannot be restored even if the deletion process is aborted.

[INDEX] (only in AVCHD mode):

[YES]:

Attach indexes to selected clips.

- 1) Select the clip to play, and push the OPERATION lever at the point for an index to be added.

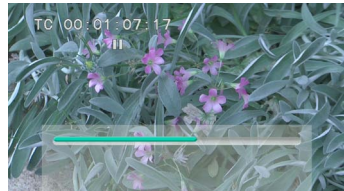

-
- 2) Select [YES] on the confirmation screen to attach an index.
 - The point in the clip at which the index will actually be attached will be accurate to within an error of 0.5 seconds.
 - To delete the index, select [INDEX]→[YES] in step 3 before performing the following.
 - 1) Select the clip to play, tilt the OPERATION lever in the <▲> direction, and pause the clip.
 - 2) Since tilting the OPERATION lever in the <◀> directions moves the pointer between the points where indexes are attached, move the pointer to the index to be deleted, and push the OPERATION lever.
 - 3) Select [YES] on the confirmation screen.

[NO]:

Returns to the previous screen.

- It is not possible to add indexes to clips shot using a consumer camcorder model.
 - It is not possible to adjust the volume during index playback.
-

[CLIP PROTECT] (only in AVCHD mode):

[YES]:

Protects selected clips. ([On] mark will be displayed.)

- Cancels protection when the protected clip is selected. ([On] mark will disappear.)

Formatting the memory card will delete all clips even if they are protected.

[NO]:

Returns to the previous screen.

- 4 Press the <MENU> button to return to the thumbnail screen.**

Repairing clips (only in DV mode)

Repair clips on which the defective clip indicator [X] (Yellow) is displayed on the thumbnail screen.

- Clips with the defective clip indicator [X] (Red) cannot be repaired.

- 1 Press the <MENU> button on the thumbnail screen.**

The thumbnail menu will be displayed.

- 2 Select [REPAIR] in the [OPERATION] item on the thumbnail menu and press [YES].**

- 3 Select a clip to repair using the OPERATION lever.**

- 4 Press the <EXEC> button.**

- 5 Select [YES] on the confirmation screen, and push the OPERATION lever.**

Clip repair will be performed.

- When shot mark has been set on the clip, the setting is canceled.
-

- Repair defective clips with this camera before moving them to a computer. Defective clips cannot be repaired once they are moved to a computer and written back on the memory card.
-

Formatting memory card/checking clip and memory card information [CARD FUNCTIONS]

Memory cards can be formatted, and clip and memory card information can be checked.

1 Press the <MENU> button.

Menu operation (Page 28 of Vol. 1)

2 Select [CARD FUNCTIONS], and push the OPERATION lever (or tilt in the <▶> direction).

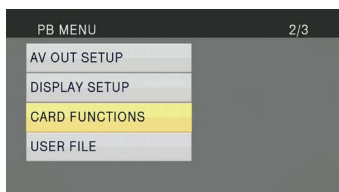

3 Tilt the OPERATION lever in the <▲> <▼> directions to select items, and push the OPERATION lever.

The screenshot shows a screen titled "CARD FUNCTIONS" with a page indicator "1/1". The screen displays a list of options: "CARD FORMAT", "CARD STATUS", and "CLIP PROPERTY". The "CARD FORMAT" option is highlighted with a yellow background.

CARD FUNCTIONS	1/1
CARD FORMAT	NO
CARD STATUS	NO
CLIP PROPERTY	NO

[CARD FORMAT]:

- Insert a memory card to be formatted into the camera.
- When a memory card is formatted, all data (including clips shot in AVCHD mode and DV mode) is erased and cannot be restored. Save any valuable data on your computer before formatting. Select [YES]/[NO] (format/do not format), and push the OPERATION lever.

[CARD STATUS]:

Displays the memory card information.
(Page 60)

[CLIP PROPERTY]:

Displays information of the selected clip.
(Page 60)

- Tilt the OPERATION lever in the <◀><▶> directions to display information of previous or following clips.

4 Press the <MENU> button to return to the thumbnail screen.

Memory card information screen

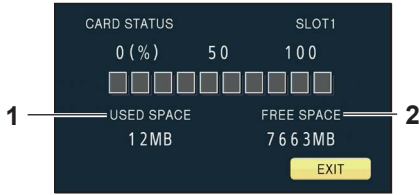

- 1 [USED SPACE]: Used space
- 2 [FREE SPACE]: Available space

Clip information screen

- In AVCHD mode

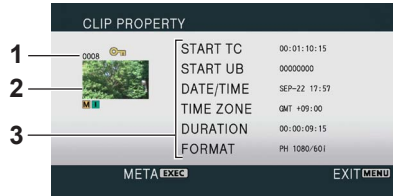

- In DV mode



1 Clip number

2 Thumbnail

For the thumbnail screen, see page 51.

3 Clip information

Displays data attached to the clip.

[START TC]:

Time code value at start of recording

[START UB]:

User information value at start of recording

[DATE/TIME]:

Date of recording and time at start of recording

[TIME ZONE]:

Displays time zone.

[DURATION]:

Clip length

[FORMAT]:

Recording format

- **Clip metadata (AVCHD mode only)**

Press the <EXEC> button while the clip information screen is being displayed to display more detailed information, including video and audio formats, and information about the videographer, etc.

Tilt the OPERATION lever in the <▲><▼> directions to check the desired information. (For details on clip metadata, see page 44.)

Useful playback functions

Fast forward/rewind playback

- 1 Tilt the OPERATION lever in the <<<<> (rewind) or <>>> (fast forward) direction during playback (or press the <SEARCH> button on the remote control).
Clip will play forwards/backwards at approximately 10 times the normal speed.
Repeat the operation to play the clip forwards/backwards at approximately 20 times the normal speed.

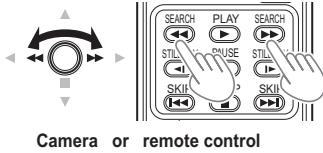

Camera or remote control

Next/previous clip

- 1 Tilt the OPERATION lever in the <▲> direction during playback to pause the clip (or press the <PAUSE> button on the remote control).
- 2 Tilt the OPERATION lever in the <<<<> (rewind) or <>>> (fast forward) direction (or press the <SKIP> button on the remote control).

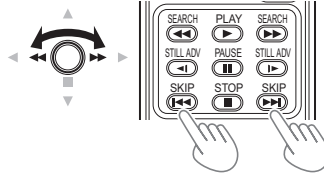

Camera or remote control

To return to normal playback, tilt the OPERATION lever in the <▲> direction (play) (or press the <PLAY> button on the remote control).

- The screen will return to the thumbnail display after the playback of the last clip is completed during fast forward playback.
- The screen will pause at the first clip after the fast rewind playback of the first clip is completed.
- No audio will be played during fast forward or rewind playback.

Frame-by-frame playback

- 1 Tilt the OPERATION lever in the <▲> direction during playback to pause the clip (or press the <PAUSE> button on the remote control).
- 2 Press the <AUDIO MON/ADV> button (or press the <STILL ADV> button on the remote control).
 - Hold down to continuously advance frame-by-frame until the button is released.
 - Hold down the <STILL ADV> button on the remote control to switch to continuous frame by frame mode. Press the <PAUSE> button to cancel.

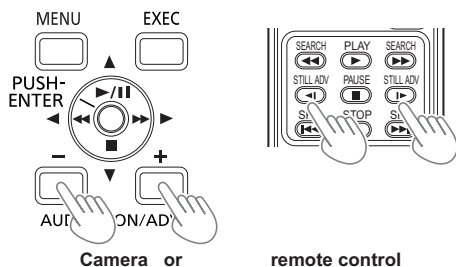

When the <+> button is pressed, the images are advanced in the forward direction frame-by-frame, and when the <-> button is pressed, they are advanced in the reverse direction at half-second intervals (in AVCHD mode) or one frame at a time (in DV mode).

To return to normal playback, tilt the OPERATION lever in the <▲> direction (play) (or press the <PLAY> button on the remote control).

Adjusting volume

- 1 The volume of audio output from the built-in speaker and headphone jack can be adjusted with the <AUDIO MON/ADV> buttons during playback. Press the <ZOOM>/<VOL> buttons if using the remote control.

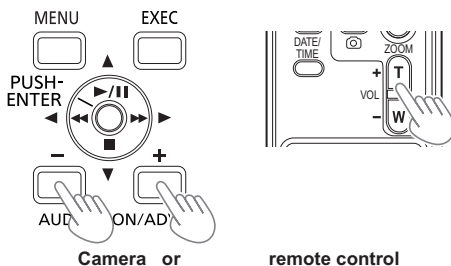

Viewing images on a television or another monitor

You can view the images on a television if you connect the unit to a television or another monitor set using a video pin cable (optional), audio pin cable (optional), or HDMI cable (optional).

- 1 Connect the camera to a television or another monitor. (Page 66)
- 2 Start playback.
 - To show the information that appears on the viewfinder and LCD monitor on a television, press the <EXT DISPLAY> button on the remote control. Press the <EXT DISPLAY> button again to clear the display.

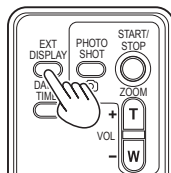

Checking the date and time of shooting

Press the <DATE/TIME> button on the remote control to show the year, month, date and time of shooting on the viewfinder and the LCD monitor. Each time you press the button, the display changes as follows.

Time
↓
Date
↓
Time and Date
↓
No display

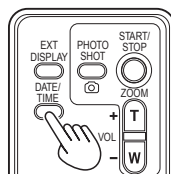

Connecting external devices

Headphones

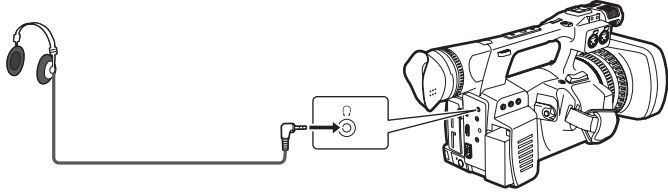

Stereo mini jack (3.5 mm)

- Sound is no longer heard from the speaker when the headphones (optional) are connected.

External microphone

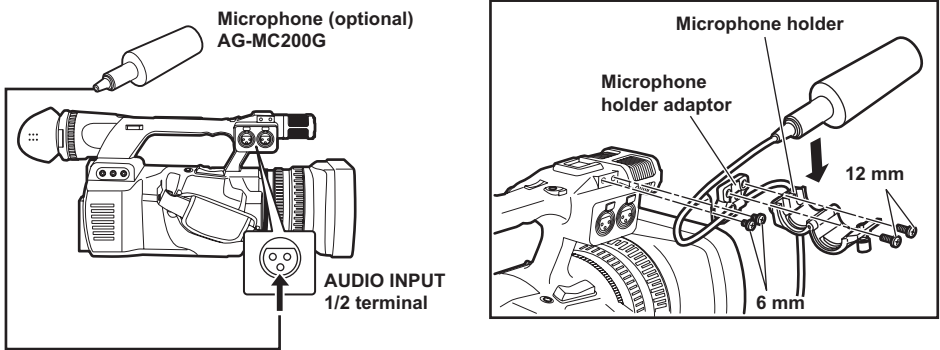

- When attaching an external microphone to the microphone shoe, use the supplied microphone holder and microphone holder adaptor.
- When attaching the microphone holder and the microphone holder adaptor, be sure to tighten the screws firmly even though you might hear a squeaking sound.
- When wiring the microphone cable, use the cable clamber of the microphone holder adaptor.

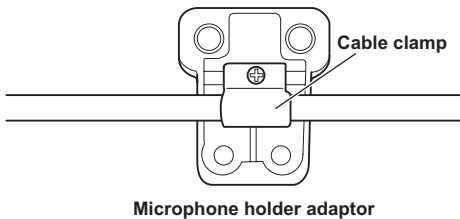

■ File transfer/nonlinear editing

You can connect a computer to the camera using a USB 2.0 cable (optional) and transfer files.

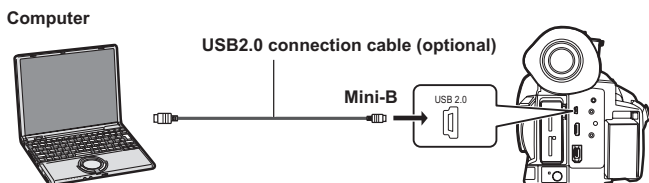

- For details on conditions of the computer and other factors, see page 68.
- No USB2.0 connection cable is included with this camera. Use a commercial double-shielded USB2.0 connection cable (shielded for noise suppression).

■ 1394 AVC transfer/nonlinear editing

You can connect a computer to the camera using an IEEE1394 cable (optional) and perform 1394 AVC transfer. (Only in DV mode)

- Set the camera to the <PB> mode.

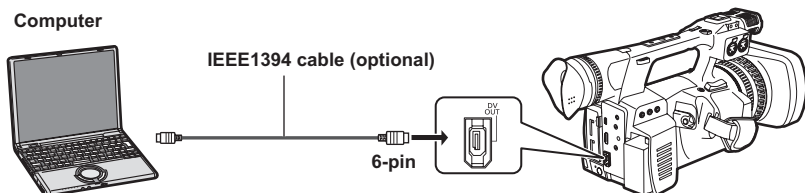

- When controlling the camera from a nonlinear editing device, you can operate the clip on the cursor position in the thumbnail screen, which is displayed on the LCD.
- When the camera cannot be controlled by the nonlinear editing device, operate the clip to import with the camera.
- When connecting and disconnecting an IEEE1394 cable, be sure to turn off the power of the device to be connected.
- When connecting an external device equipped with a 4-pin type IEEE1394 terminal, connect the <DV OUT> terminal (6-pin) first.
- Use a double-shielded IEEE1394 cable.

Digital device

■ 1394 AVC transfer

You can connect a digital device to the camera using an IEEE1394 cable (optional) and perform 1394 AVC transfer. (Only in DV mode)

- Set the camera to the <PB> mode.

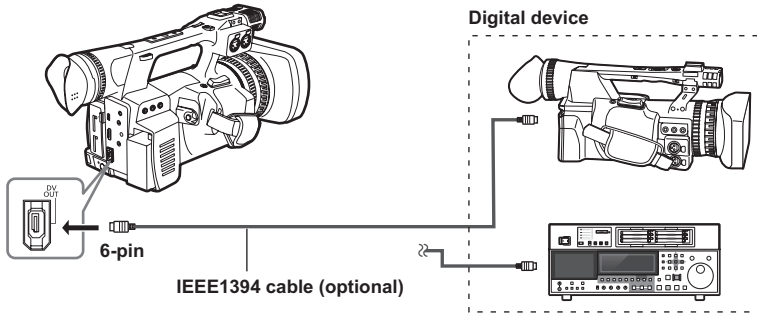

- When connecting and disconnecting an IEEE1394 cable, be sure to turn off the power of the device to be connected.
- When connecting an external device equipped with a 4-pin type IEEE1394 terminal, connect the <DV OUT> terminal (6-pin) first.
- Use a double-shielded IEEE1394 cable.

TV/Monitor

Only the output signals from the camera are shown.

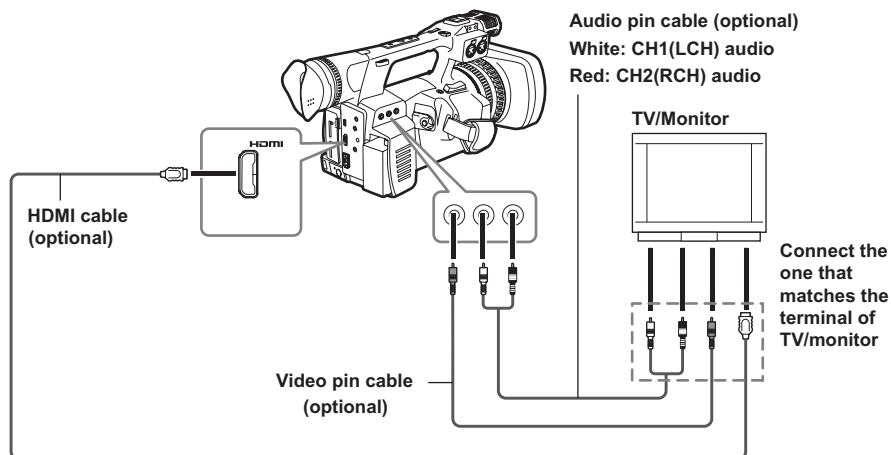

■ When outputting video and audio signals from the camera to an external device, connect to the input terminals of the external device.

- Use an HDMI cable (optional) with double-shield or higher.
- It is recommended that you use an HDMI cable manufactured by Panasonic.
- This camera is not compatible with VIERA Link.

■ Limitations of image output

- Some displays, such as time code display and audio level meter display may not be visible on the videos output from the output terminal.

■ Output list when external devices (TV/Monitor) are connected

Mode	Menu settings			Output terminal format		
	REC FORMAT	HDMI OUT SEL	DOWNCON MODE	HDMI OUT	VIDEO OUT	DV OUT
AVCHD	1080/60i(30P), 1080/24P	1080i/720P	SIDE CROP LETTER BOX SQUEEZE ^{*1}	1080/60i	480/60i	No output
	720/60P(30P), 720/24P			720/60P	480/60i ^{*2}	
	1080/60i(30P), 1080/24P 720/60P(30P), 720/24P	DOWN CONV	SIDE CROP LETTER BOX SQUEEZE	480/60P ^{*3}	480/60i	
DV	480/60i 480/30P 480/24P	Disabled	Disabled	No output	480/60i	480/60i

*1 Enabled only when output is performed with <VIDEO OUT>.

*2 Video is not output from <VIDEO OUT> when HDMI connection is in use. Output when HDMI connection is not used.

*3 In AVCHD mode, if the [HDMI OUT SEL] item on the [AV OUT SETUP] screen is set to [DOWN CONV], the signal is converted to progressive (480P) and output from the HDMI OUT terminal.

Nonlinear editing

Nonlinear editing of video data on memory cards can be performed by connecting the camera via the USB2.0 connection cable to a computer for editing (Page 64).

Use a sufficiently charged battery or the AC adaptor.

The following conditions are necessary for USB connection.

- PC with Windows XP, Windows Vista, or Windows 7, or Macintosh with Intel CPU (Intel Mac)
- USB2.0 (High Speed, Mass Storage Class) compatibility (not compatible with USB1.1)
- Only connect to one computer at a time.
- Camera cannot be operated if a hub or other device is connected between the camera and computer.

1 Insert a memory card into the camera, and turn the **POWER/MODE** switch of the camera <ON>. (Page 27 of Vol.1)

2 Connect the camera to a computer with a **USB2.0** connection cable.

Turn on the power of the computer before connecting.

3 Select [PC].

Dubbing can be performed to a Blu-ray Disc Recorder, etc. by selecting [RECORDER].

4 Perform nonlinear editing on the computer.

The contents of the memory card will appear as a removable disk icon within My Computer or the desktop on the computer screen. (Page 69) (Example) Windows



Removable disk (E:)

(Example) Macintosh



NO NAME

- When copying files from the camera to a computer, take care to ensure that files are not accidentally overwritten.
- For more details, refer to the operating instructions of your computer editing software.
- When changing memory cards, always ensure that the access lamp is not flashing and that the memory card is not currently being accessed.
- Camera functions cannot be used when the camera is connected to a computer.
- Always perform "safe hardware removal" when disconnecting the cable.
- The data on the memory card cannot be accessed when the memory card slot cover is open.
- If you use the battery and connecting a USB cable, no output will be performed from <HDMI> and <VIDEO OUT> terminals. When USB cable is connected, a message appears and then disappears on the LCD monitor and viewfinder, which is displayed again when operating the OPERATION lever. (This does not occur when connecting an AC adaptor.)

5 Turn off the power of the camera.

- If the camera cannot be correctly recognized by the computer, you may be able to remedy that by one of the following methods.
 - Turn the power of the camera and the computer off and back on again.
 - Remove the memory card from the camera and reinsert it.
 - Connect to a different USB2.0 terminal on the computer.
 - If you are using an SDXC memory card, some computers may not recognize the data. Make sure your computer supports SDXC cards.
-

How to handle data recorded on the memory card

AVCHD mode

Data recorded in AVCHD format offers excellent compatibility with computers due to the file type, but since this format includes not only video and audio data, but also a variety of important information, the folder structure will consist of file associations as illustrated in the diagram on the right. If even part of this information is modified or deleted, the data may no longer be recognized as AVCHD data, or the memory card may not longer be able to be used with AVCHD devices.

To prevent the loss of any part of the information when transferring data on the memory card to a computer or when copying data stored on a computer back onto the memory card, be sure to use the dedicated AVCCAM viewer. The AVCCAM Viewer can also be downloaded from the following website.

(Compatible OS: Windows XP/Windows Vista/Windows 7 or Mac OS X10.4 or later /Mac OS 10.5/Mac OS 10.6)

<http://pro-av.panasonic.net/>

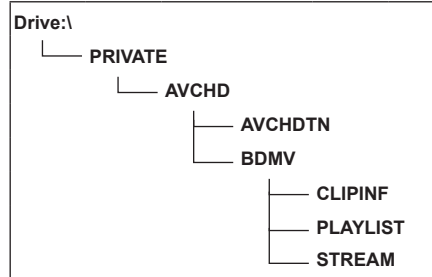

■ Concerning the handling of the camera's metadata

The metadata supported by the camera is held in a special manufacturer area in the control file area for the AVCHD standard.

If files are deleted or copied, if clip protection is added or removed or if other such editing operations have been performed using editing software or a camera recorder which does not support this camera's metadata, the special area for the metadata will be erased, and the shot marks and indexes added by the camera as well as the PH mode information and other information will be lost.

Therefore, before proceeding with these kinds of editing operations, check whether the camera's metadata is supported.

In DV mode

Video and audio data in DV format are AVI Type2 files and the folder structure will consist of file associations as illustrated in the diagram on the right.

"VIDEO" folder contains saved video and audio data (such as "001AB00.AVI"). "ICON" folder contains the thumbnails of video data.

Since these folders contain other information required for playback on this camera, modifying or deleting any of them may disable playback of data.

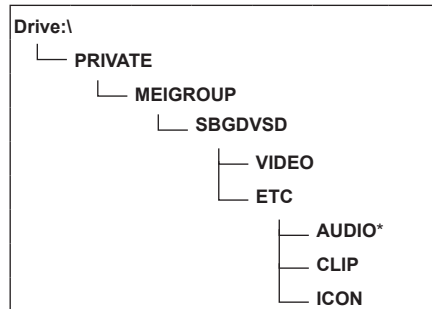

* AUDIO folder is not created for this camera.

Dubbing

Dubbing with Blu-ray Disc Recorder

- In this manual, “Blu-ray disc recorder” is referred to as “BD recorder”.

Insert a memory card containing video shot in AVCHD mode using the camera into a Blu-ray Disc Recorder manufactured by Panasonic to save the contents in a Blu-ray Disc, DVD, or HDD.

- Use a Blu-ray Disc Recorder that supports AVCHD. However, dubbing may not be performed even when AVCHD is supported. For details on how to perform dubbing onto a Blu-ray Disc, read the operating instructions of the Blu-ray Disc Recorder.
- When dubbing of videos shot with the camera is performed on a Blu-ray Disc (BD-RE, BD-R), HDD, or DVD, metadata information supported by the camera will be lost. In order to perform dubbing including metadata information, use the dedicated software AVCCAM viewer. (Page 69)

1 Remove the memory card from the camera after shooting.

Turn the power of the camera off before removing the memory card.

2 Insert the memory card into the memory card slot of the Blu-ray Disc/DVD recorder.

For details on how to perform dubbing onto a Blu-ray Disc, read the operating instructions of the Blu-ray Disc/DVD recorder.

Screen displays

Normal displays

■ During AVCHD mode

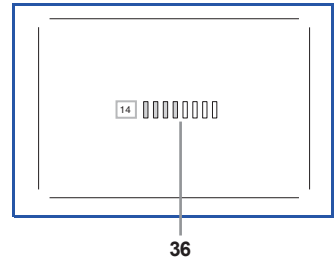
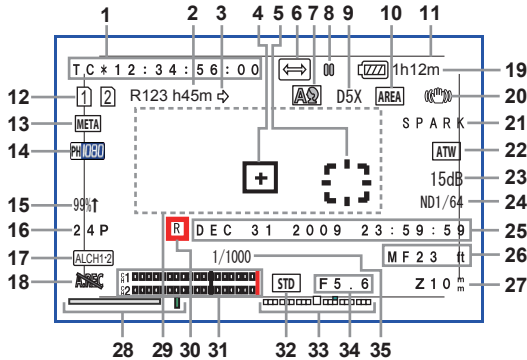

■ During DV mode

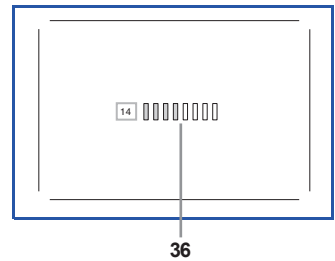
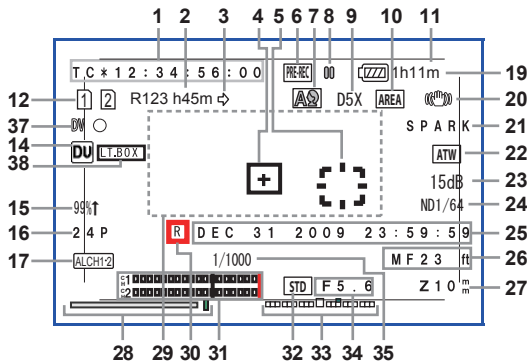

1 Time code display

Every time you press the <COUNTER> button, you switch to the following data (or no display).

[COUNTER]:

Counter value

Displayed when [TOTAL] is selected from the [REC COUNTER] item on the setup menu [DISPLAY SETUP] screen.

[CLIP]:

The counter value of [CLIP] for each shooting
Displayed when [CLIP] is selected from the [REC COUNTER] item on the setup menu [DISPLAY SETUP] screen.

- The count is not displayed in <PB> mode.

[TC]:

Time code value

When a time code value has not been correctly read from the memory card, [TC *] is displayed.

[UB]:

User information value

When a user information value has not been correctly read from the memory card, [UB *] is displayed.

2 Media capacity display

Displays remaining capacity for the recording frame rate set from the [REC FORMAT] item on the setup menu [RECORDING SETUP] screen. Not displayed during <PB> mode.

- Time displayed is a guideline only.
- The remaining capacity of slot 2 is also displayed here.

3 Recording mode display

[↔]: During relay recording

- The media capacity display displays the total remaining capacity of two memory cards.

[☐]: During SIMUL REC

- The media capacity display displays the capacity possible for SIMUL REC.

4 Center marker frame display

Displayed when the [CENTER MARKER] item on the setup menu [DISPLAY SETUP] screen is [ON].

5 AREA frame display

Displays the range of the AREA function.

6 Recording function display

[PRE-REC]: When pre-rec mode is ON

[↔]: During INTERVAL REC mode (AVCHD mode only)

7 <AUTO/MANU> switch

Displayed when you switch the <AUTO/MANU> switch to <AUTO>.

[A]: When shooting in Auto mode

[A☑]: When shooting in auto mode that allows [FACE DETECT] function

Displayed when you switch the <AUTO/MANU> switch to <MANU>.

[☑]: When shooting in manual mode that allows [FACE DETECT] function (when setting auto focus or auto iris)

8 Operation status display

[○] (Red): Shooting

[⏸] (Green): Shooting paused

[▶] (Green): Playback

[⏸] (White): Playback paused

INDEX [⏸]: Playback paused at INDEX position

[⏮ ▶] ([◀ ⏮]): Frame-by-frame playback (Frame-by-frame reverse playback)

[▶⏮] ([▶◀]): Cued playback (cued reverse playback)

[▶▶] ([▶▶]): Fast forward/fast forward (Rewind/fast rewind playback)

[▶] ([◀]): Pause at final scene (pause at starting scene)

9 Digital zoom magnification display

Displays digital zoom magnification.

[D2X]: 2X

[D5X]: 5X

[D10X]: 10X

10 AREA operation display

Displayed when an operation is being performed in the area inside the function frame with the <FUNCTION> knob.

11 Safety zone

Displays the range set with the [SAFETY ZONE] item (Page 89) on the setup menu [DISPLAY SETUP] screen.

- During AVCHD mode

[90%]: 90% display at 16:9

[4:3]: 100% display at 4:3

[14:9]: 100% display at 14:9

[1.85:1]: 100% display at 1.85:1

[2:1]: 100% display at 2:1

[2.35:1]: 100% display at 2.35:1

[2.39:1]: 100% display at 2.39:1

[GRID]: 16:9 angular field of view with nine grid lines

- During DV mode

[90%]: 100% display at 16:9

[4:3]: 100% display at 4:3

12 Media information display

Displays basic information about inserted memory cards. Information regarding slot 1 is displayed above, and information regarding slot 2 is displayed below.

[] []:

Recordable memory card (white)

- Displayed in green if used for recording.

[]:

Write protect is on

[]:

Non-recordable memory card

[]:

Memory card is full

- Recording is sometimes possible even when this icon is displayed.
- Depending on the space and type of memory card, this icon may not be displayed even if recording stops while shooting because the memory card is full.

[]:

Playback only memory card

Memory cards with more than 1000 clips recorded become playback only memory cards.

[]:

No memory card inserted in both memory card slots 1 and 2

- Flashes red.

13 Metadata recording display (AVCHD mode only)

[]: When metadata recording is [ON]

No display: When metadata recording is [OFF]

14 Recording format display (Page 85)

15 Marker luminance display

During marker display, the image level near the center of the screen is displayed as [0%] - [99%]. [99%↑] is displayed when [99%] is exceeded.

- When the AREA Y-GET function is operating, the image level near the center of the AREA frame is displayed. (Page 25)

16 Frame rate display

Displays the recording frame rate.

Not displayed when 1080/60i.

17 Audio limiter display

Displays when the AUDIO AUTO/MANU CH1/CH2 switch is set to <MANU>, and the [AUDIO LIMITER CH1]/[AUDIO LIMITER CH2] items on the setup menu [RECORDING SETUP] screen are [ON].

[]: When [AUDIO LIMITER CH1] = [ON]

[]: When [AUDIO LIMITER CH2] = [ON]







[]: When [AUDIO LIMITER CH1],
[AUDIO LIMITER CH2] = [ON]

18 Recording audio display (AVCHD mode only)

[]: An indication appears to show that audio is not recorded.

19 Remaining battery charge display

When using Panasonic batteries compatible with this camera, the remaining battery charge is displayed in minutes. Some time passes until displayed.

- As the remaining battery charge becomes lower, the display changes to [] → [] → [] → []. When there are less than 3 minutes [] flashes in red, and when there is no capacity [] flashes.
- The remaining battery charge may not be displayed correctly when used in high or low temperatures, or when the camera has not been used for a long period of time. To display the remaining battery charge correctly, fully charge the battery and recharge it after using it completely. (Even when doing so, batteries used for lengthy periods in high and low temperatures or those repeatedly charged sometimes do not display the battery level correctly.)
- Since the time on the battery level display may vary depending on usage conditions, use it as a guideline.
- When switching modes, performing REC CHECK, or changing the LCD brightness, the time display will disappear for a moment to recalculate the remaining battery charge time.
- Not displayed when using an AC adaptor.

20 Optical image stabilizer display

[]: displayed when the optical image stabilizer is ON.

21 Scene file name display (Page 40)

22 [AWB] information display

Displays white balance information.

[ATW]: When [ATW] is set

[P3.2 K/P5.6 K/VAR]: In the case of preset

[Ach/Bch]: In the case of A/B

[LOCK]: When [ATW] is locked

23 Gain display

Displays the gain value of the image amplifier configured. During Auto mode, [AGC] is displayed.

24 ND filter display

ND filter selected is displayed.

25 Date and time display

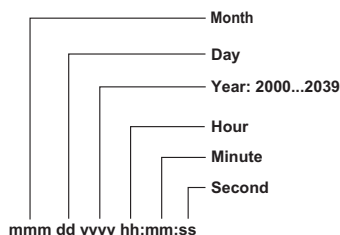

Order can be changed with the [DATE FORMAT] item on the setup menu [DISPLAY SETUP] screen.

26 Focus control information display

Displays the focus control information with [99] - [00].

In the auto focus mode and the manual focus mode, [AF] and [MF] appear, respectively. In addition, when the [MF ASSIST] item on the setup menu [SW MODE] screen is set to [ON], [MA] appears in the manual focus mode. When the macro control is set, [AF], [MF], or [MA] is displayed in black & white reverse.

[95] (Focus distance: infinity) - [00] (Focus distance: approximately 5 cm)

Depending on the zoom position, it may not be within the macro range. Also, the lower limit of the macro range may differ depending on the zoom position.

The units can be switched between feet and m with the [ZOOM&FOCUS] item on the setup menu [DISPLAY SETUP] screen.

27 Zoom position display

The zoom position is displayed with [Z00] (maximum wide-angle) - [Z99] (maximum zoom).

The unit can be switched to [mm] with the [ZOOM&FOCUS] item on the setup menu [DISPLAY SETUP] screen.

The focus position display does not move linearly. The unit is set as [NUMBER] in the factory settings.

28 FOCUS BAR display

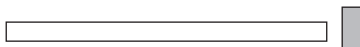

Displays the preceding bar in the bottom left of the LCD monitor/viewfinder. Digitizes and displays high-frequency component volumes for videos.

White bar: focus bar display

Green line: peak display

29 Information display

The following information is displayed depending on the situation.

- Performance of the auto white balance or the auto black balance
- Warning (Page 76)
- The ND filter recommended under the current shooting conditions is displayed.
- The AWB error message ([LOW LIGHT]/[LEVEL OVER]) (Page 21)
- The functions assigned to the USER buttons while you hold down the <DISP/MODE CHK> button.

30 Time stamp display

Displayed when the [TIME STAMP] item on the setup menu [RECORDING SETUP] screen is [ON].

31 Audio level meter display (Page 39)

32 Auto iris control display

- [STD]: Standard auto iris control
- [SPOT]: Auto iris control for spotlight
- [BACK]: Auto iris control for the backlight compensation

33 IRIS METER display

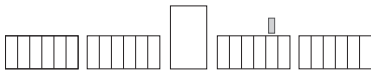

Displays the preceding bar in the bottom right of the LCD monitor/viewfinder.

Center: Indicates the normal light intensity.

Right: Indicates high-light intensity.

Left: Indicates low-light intensity.

Green dots on display:

Indicate the compensation amount during AUTO IRIS.

34 Iris display

Displays F value.

35 Shutter speed display

Displays the shutter speed.

36 Monitor audio level meter

When you press the <AUDIO MON/ADV> button, the sound volume output from the built-in speaker and headphone jack is displayed.

37 DV control device status display (DV mode only)

Displays the status of the device connected to the <DV OUT> terminal.

[DV ○] (red): Shooting

[DV □] (red): Shooting paused

[DV ⊗] (red): Device cannot be controlled or cannot be in shooting/shooting pause status

[DV]: Device is not connected

38 Recording aspect display (DV mode only)

Displayed when recording aspect is set to [LETTER BOX].

Main warning displays

The main warning displays appearing on the LCD monitor or viewfinder are as follows. If a warning display is not listed, carefully check the message displayed.

■ A

[ALL DATA WILL BE DELETED. (INCLUDING CLIP OF AVCHD) FORMAT THE CARD NOW? (SLOT1)]

If you format the memory card, all the recorded data will be deleted. (Including AVCHD clips.)
Do you format the memory card? (SLOT1)

■ C

[CANNOT BE USED DUE TO INCOMPATIBLE DATA.]

Cannot be used because the standard for the data is different.

[CANNOT DELETE.]

Clip cannot be deleted.

[CANNOT DELETE WITH THIS BUTTON]

Clip cannot be deleted.

[CANNOT PLAY.]

No playback is possible.

[CANNOT PLAY WITH THIS BUTTON]

No playback is possible.

[CANNOT RECORD PH MODE AND HA MODE INTO THIS CARD.]

This memory card cannot be recorded to in PH mode or HA mode.

[CANNOT RECORD. THE NUMBER OF CLIPS HAS EXCEEDED THE MAXIMUM LIMIT.]

The maximum number of clips has been reached and no further clips can be recorded.

[CANNOT SET THE NUMBER OF INDEXES HAS EXCEEDED THE MAXIMUM LIMIT.]

No further indexes can be set because the number of indexes will exceed the maximum limit.

[CANNOT SET PRE-REC, CARD CAPACITY TOO LOW.]

PRE-REC cannot be set because the remaining memory card capacity is low.

[CARD DOOR OPENED.]

The memory card door is open.

[CARD ERROR. PLEASE REFORMAT.]

Formatting has failed. This memory card needs to be reformatted.

[CARD FULL.]

The memory card is full.

[CHECK CARD.]

Please check the memory card.

If a memory card that has been used before in another device or computer is used for the first time in this camera, [CHECK CARD.] is displayed, and all operations may be disabled.

In such a case, perform the following:

- 1) Remove the memory card from the camera and insert it again. (Page 15)
The camera recognizes the memory card and cancels the [CHECK CARD.] display.
- 2) If the [CHECK CARD.] display is not disappeared even after removing and inserting the memory card several times, check the contents of the memory card on a computer, and erase all the data.
- 3) Format the memory card with the camera. (Page 13)

If the data on the memory card cannot be either read or erased on a computer, the memory card may be damaged. Use another memory card.

[CONTROL DATA ERROR HAS BEEN DETECTED.]

An error has been detected in the control information.

■ D

[DISCONNECT USB CABLE.]

When turning off the power, disconnect the USB connection cable.

■ I

[INCOMPATIBLE CARD. PLEASE CHECK CARD.]

Displayed when the writing speed of the memory card in use is slow and recording may not be performed.

■ N

[NO CARD]

No memory card is inserted.

■ R

[REPAIR CLIP?]

Do you wish to repair clips now?

■ S

[SET DATE AND TIME]

Set the date and time.

■ T

[THE CLIP IS PROTECTED. PLEASE CANCEL PROTECTION.]

The clip is protected. Please release the protection.

[THE RECORDING IS STOPPED (OVER THE LIMITATION)]

Recording will stop. (Continuous recording for 12 hours)

[THE TC MODE IS CHANGED TO "NDF"]

NDF is selected as the TC mode setting.

[THIS BATTERY CANNOT BE USED.]

This battery cannot be used.

[THIS CARD CANNOT RECORD IN VIDEO MODE.]

This memory card cannot be used for video recording.

[THUMBNAIL DATA ERROR IS DETECTED.]

An error has been detected in the thumbnail information.

■ U

[UNABLE TO FORMAT.]

The memory card cannot be formatted.

■ W

[WRITE PROTECT]

This memory card is write-protected.

Error displays

The following messages are displayed when an error has occurred in the camera or the memory card. If the problem is not solved by switching the power off and back on again, either change the memory card in accordance with the instructions displayed, or consult your dealer.

■ E

[ERROR OCCURRED. PLEASE TURN POWER OFF.]

Displayed when an error has occurred on the camera. Turn off the power.

■ R

[REC WARNING]

Displayed when an error has occurred during recording. Start the recording again. If the warning appears again, consult your dealer.

- Switch the power off if the warning continues to appear.
- Try inserting a different memory card if the warning appears again after restarting recording.

■ S

[SYSTEM ERROR TURN POWER OFF]

Displayed when an error has occurred in the system. Switch off the power and back on again.

- If this error is displayed when accessing the memory card, such as when deleting a clip, the memory card may be damaged. Please replace it with a new memory card.
- If this error is displayed during repair, please use the AVCCAM Restorer contents repair software. (Page 16)

Selecting the display items

Display the following items on the viewfinder and LCD monitor by pressing the <DISP/MODE CHK> button or by setting the [OTHER DISPLAY] item (Page 91) on the setup menu [DISPLAY SETUP] screen.

	Displays	MODE CHK	DISPLAY	[OTHER DISPLAY] settings		
				[ALL]	[PARTIAL]	[OFF]
1	Time code display	—	—	—	—	—
2	Media capacity display	✓	✓	—	—	—
3	Recording mode display	✓	✓	—	—	—
4	Center marker frame display	—	—	—	—	—
5	AREA frame display	—	—	—	—	—
6	Recording function display	✓	✓	—	—	—
7	<AUTO/MANU> switch	✓	✓	✓	✓	x
8	Operation status display	—	—	—	—	—
9	Digital zoom magnification display	✓	✓	✓	✓	x
10	AREA operation display	✓	✓	—	—	—
11	Safety zone	—	—	—	—	—
12	Media information display	✓	✓	—	—	—
13	Metadata recording display (AVCHD mode only)	✓	✓	✓	x	x
14	Recording format display	✓	✓	✓	x	x
15	Marker luminance display	—	—	—	—	—
16	Frame rate display	✓	✓	✓ ^{*1}	x	x
17	Audio limiter display	✓	✓	✓	x	x
18	Recording audio display (AVCHD mode only)	✓	✓	✓	x	x
19	Remaining battery charge display	✓	✓	—	—	—
20	Optical image stabilizer display	✓	✓	✓	✓	x
21	Scene file name display	✓	✓	✓	x	x
22	[AWB] information display	✓	✓	✓	✓ ^{*2}	x
23	Gain display	✓	✓	✓	✓ ^{*3}	x
24	ND filter display	✓	✓	✓	x	x
25	Date and time display	✓	✓ ^{*4}	—	—	—
26	Focus control information display	✓	✓	—	—	—
27	Zoom position display	✓	✓	—	—	—
28	FOCUS BAR display	✓	✓	—	—	—
29	Information display	✓	—	—	—	—
30	Time stamp display	✓	✓	—	—	—
31	Audio level meter display	✓	✓	—	—	—
32	Auto iris control display	✓	✓	✓	✓	x
33	IRIS METER display	✓	✓	—	—	—
34	Iris display	✓	✓	✓	✓	x
35	Shutter speed display	✓	✓	✓	✓	x
36	Monitor audio level meter	—	—	—	—	—
37	DV control device status display (DV mode only)	—	—	—	—	—
38	Recording aspect display (DV mode only)	✓	✓	✓	✓	x

✓: Displayed x: Not displayed —: Displayed depending on other settings.

Items marked as ✓ in the MODE CHK column appear when you press and hold the <DISP/MODE CHK> button.

Items marked with ✓ in the DISPLAY column disappear when you press the <DISP/MODE CHK> button.

*1 Not displayed when the frame rate is set to 60i.

*2 Ach and Bch are not displayed.

*3 0 dB is not displayed.

*4 When both "25 Date and time display" and "30 Time stamp display" are displayed, the display will not disappear even if you press the <DISP/MODE CHK> button.

Setup menu list

[SCENE FILE] screen

Item	Display mode	Description of settings
[LOAD/SAVE/INIT]	<CAMERA>	<p>[LOAD]: Loads the scene file settings saved in this camera.</p> <p>[SAVE]: Saves the updated scene file settings.</p> <p>[INIT]: Returns the scene file settings selected using the <SCENE FILE> dial, to the factory settings.</p> <p>[NO]: Returns to the previous screen.</p>
[SYNC SCAN TYPE]	<CAMERA>	<p>Selects the synchro scan display setting.</p> <p>[deg.]: Sets to angle display.</p> <p>[sec]: Sets to speed display.</p>
[SYNCHRO SCAN]	<CAMERA>	<p>Adjusts the synchro scan shutter speed used for shooting images on a TV screen, etc.</p> <p>Holding the OPERATION lever tilted upward or downward will cause the values to change at a faster rate.</p> <ul style="list-style-type: none"> • When [SYNC SCAN TYPE] = [sec] <ul style="list-style-type: none"> 60i/60 P mode: [1/60.0] - [1/249.8] secs 30 P mode: [1/30.0] - [1/48.0] - [1/249.8] secs 24 P mode: [1/24.0] - [1/48.0] - [1/249.8] secs • When [SYNC SCAN TYPE] = [deg.] <ul style="list-style-type: none"> [3.0 d] - [180.0 d] - [360.0 d] (0.5 d increments, angle display)
[DETAIL LEVEL]	<CAMERA>	<p>Adjusts the level of the image outline correction (in the horizontal and vertical directions).</p> <p>[-7] ... [0] ... [+7]</p>
[V DETAIL LEVEL]	<CAMERA>	<p>Adjusts the level of outline correction in the vertical direction.</p> <p>[-7] ... [0] ... [+7]</p>
[DETAIL CORING]	<CAMERA>	<p>Adjusts the level of noise reduction of the detail signal.</p> <p>Set to - for a clearer image, but noise increases slightly.</p> <p>Set to + to reduce noise.</p> <p>[-7] ... [0] ... [+7]</p>

_____ is the factory default mode for the <SCENE FILE> dial <F1>.

Item	Display mode	Description of settings
[CHROMA LEVEL]	<CAMERA>	Adjusts the chroma level. [-7] ... [0] ... [+7]
[CHROMA PHASE]	<CAMERA>	Adjusts the chroma phase. [-7] ... [0] ... [+7]
[COLOR TEMP Ach]	<CAMERA>	Make fine adjustments to the color temperature (after white balance Ach adjustment). [-7] ... [0] ... [+7]
[COLOR TEMP Bch]	<CAMERA>	Make fine adjustments to the color temperature (after white balance Bch adjustment). [-7] ... [0] ... [+7]
[MASTER PED]	<CAMERA>	Adjusts the master pedestal (black level of the image) as the basis for images. [-15] ... [0] ... [+15]
[A.IRIS LEVEL]	<CAMERA>	Sets the desired AUTO IRIS level. [-6] ... [0] ... [+6]
[DRS]	<CAMERA>	Selects the [DRS] (dynamic range stretcher) function. [ON]: Enables the [DRS] function. [OFF]: Disables the [DRS] function. • If you assign the [DRS] function to the USER button, pressing the USER button switches it ON/OFF.
[DRS EFFECT]	<CAMERA>	Selects the level of the [DRS] (dynamic range stretcher) function. It enables the dynamic range to be expanded by compressing the level of the video signals in the high-brightness areas where overexposure results during normal shooting. [1], [2], [3] • The higher the number of the setting, the higher the compression level of the high-brightness areas.
[GAMMA]	<CAMERA>	Selects the gamma curve. [HD NORM]: This gamma setting is suitable for HD shooting. [LOW]: Makes a mellow image using the gamma curve that has a gentle incline in low-brightness curve. The contrast sharpens. [SD NORM]: This is the normal video setting carried over from Panasonic AG-DVX100 series. [HIGH]: Expands the tone of dark parts and makes a brighter image using the gamma curve that has a sharp incline in low-brightness curve. The contrast softens. [B.PRESS]: Makes the contrast sharper than LOW. [CINE-LIKE D]: Uses a gamma curve designed to create cinema-like images. [CINE-LIKE V]: Uses a gamma curve designed to create cinema-like images with emphasized contrast. • When you select [CINE-LIKE] gamma, we recommend setting the lens aperture lower than normal image level (approximately 1/2) for optimal results.

_____ is the factory default mode for the <SCENE FILE> dial <F1>.

Item	Display mode	Description of settings
[KNEE]	<CAMERA>	To avoid overexposure, select the compression level (knee point) of the high intensity video signals received through the image pickup device. [AUTO]: Sets the level automatically according to the received signals. [LOW]: Low setting (Compression starts at approx. 80%) [MID]: Medium setting (Compression starts at approx. 90%) [HIGH]: High setting (Compression starts at approx. 100%) <ul style="list-style-type: none"> • Not available when a [DRS] value is set, or when [GAMMA] is set to [CINE-LIKE].
[MATRIX]	<CAMERA>	Selects the MATRIX table suitable for the desired color expression during shooting. [NORM1]: Suitable for shooting in the open air or under a halogen lamp. [NORM2]: Suitable for brighter colors than the [NORM1] mode. [FLUO]: Suitable for shooting under fluorescent lights indoors. [CINE-LIKE]: Suitable for cinema-like images.
[SKIN TONE DTL]	<CAMERA>	Switches skin tone details [ON]/[OFF]. Select ON to reduce the skin tone details and soften the skin tone. [ON] [OFF]
[CARD READ]	<CAMERA>	Reads scene files from the memory card. [SLOT1]: Reads scene files (all scenes from <F1> to <F6>) saved on the memory card of slot 1 after selecting the setting values. [SLOT2]: Reads scene files (all scenes from <F1> to <F6>) saved on the memory card of slot 2 after selecting the setting values. [NO]: Returns to the previous screen.
[CARD WRITE]	<CAMERA>	Saves scene files to the memory card. [SLOT1]: Saves the setting values of scene files (all scenes from <F1> to <F6>) on the memory card of Slot 1. [SLOT2]: Saves the setting values of scene files (all scenes from <F1> to <F6>) on the memory card of Slot 2. [NO]: Returns to the previous screen.
[NAME EDIT]	<CAMERA>	Edits the name of the currently selected scene file. [YES] [NO]

_____ is the factory default mode for the <SCENE FILE> dial <F1>.

[SW MODE] screen

Item	Display mode	Description of settings
[FUNCTION KNOB]	<CAMERA>	Sets the function assigned to the AREA operation of the <FUNCTION> knob. [INH]: No function is assigned. [FOCUS]: AUTO FOCUS / FOCUS BAR function [IRIS]: AUTO IRIS/IRIS METER function [Y GET]: [Y GET] (Luminance measurement) function [FOCUS/IRIS]: Simultaneous operation of [FOCUS] and [IRIS] described above [FOCUS/Y GET]: Simultaneous operation of [FOCUS] and [Y GET] described above
[LOW GAIN]	<CAMERA>	Sets the gain value assigned to the <L> position of the <GAIN> switch. [0dB], [3dB], [6dB], [9dB], [12dB], [15dB], [18dB]
[MID GAIN]	<CAMERA>	Sets the gain value assigned to the <M> position of the <GAIN> switch. [0dB], [3dB], [6dB], [9dB], [12dB], [15dB], [18dB]
[HIGH GAIN]	<CAMERA>	Sets the gain value assigned to the <H> position of the <GAIN> switch. [0dB], [3dB], [6dB], [9dB], [12dB], [15dB], [18dB]
[SUPER GAIN]	<CAMERA>	Selects the super gain value assigned to the USER button. [24dB], [30dB]
[ATW]	<CAMERA>	Assigns [ATW] (Auto Tracking White) function on the <WHITE BAL> switch (on the position <A>, , or <PRST>). When the [ATW] function is assigned to the USER button, the USER button operation remains effective. [Ach]: Activates the [ATW] function when the <WHITE BAL> switch is set to <A>. [Bch]: Activates the [ATW] function when the <WHITE BAL> switch is set to . [PRST]: Activates the [ATW] function when the <WHITE BAL> switch is set to <PRST>. [OFF]: Deactivates the [ATW] function with <WHITE BAL> switch
[MF ASSIST]	<CAMERA>	Activates automatic final focus when in manual focus mode. [ON]: Activates automatic final focus. [OFF]: Deactivates automatic focus. <ul style="list-style-type: none"> • When there is large discrepancy in focus, you may not be able to focus. • Cannot be activated by an operation on the remote control connected to the <CAM REMOTE> terminal.
[HANDLE ZOOM]	<CAMERA>	Sets the zoom speed assigned to positions of the <HANDLE ZOOM> switch. [L/OFF/H]: Sets LOW (slow)/OFF/HIGH (fast) to the <1>/<2>/<3> positions. (OFF deactivates ZOOM operations.) [L/M/H]: Sets LOW (slow)/MID (medium)/HIGH (fast) to the <1>/<2>/<3> positions. [L/OFF/M]: Sets LOW (slow)/OFF/MID (medium) to the <1>/<2>/<3> positions. (OFF deactivates ZOOM operations.)

_____ is the factory default mode.

Item	Display mode	Description of settings
[USER1]	<CAMERA> <PB>	<p>Sets the function assigned to the <USER1> button.</p> <p>[INH]: No function is assigned.</p> <p>[FACE DETECT]: This is the face detection function. Performs the AUTO IRIS/ AUTO FOCUS operation centering around the detected face. Enabled when both focus control and iris control are set to auto.</p> <p>[WFM]: Selects the wave form display. This is displayed on the LCD when shooting.</p> <p>[EVF DTL]: Pressing the button emphasizes the outlines of the screen images, making it easier to focus.</p> <p>[D.ZOOM]: Selects magnification of DIGITAL ZOOM function. Each press of the button moves to the next setting in a sequence of OFF (x 1) →x 2→x 5→x 10→, and OFF (x 1).</p> <p>[DRS]: Switches the [DRS] function [ON]/[OFF].</p> <p>[S.GAIN]: Selects the set value ([24dB]/[30dB]).</p> <p>[ATW]: Switches the [ATW] function [ON]/[OFF].</p> <p>[ATW LOCK]: Fixes the white balance value when the button is pressed during [ATW]. Press again to perform [ATW] function.</p> <p>[SHOT MARK]: Records shot mark. (Page 29) Enabled during recording, thumbnail display, and clip display.</p> <p>[INDEX]: Enabled during index recording (Page 29) (AVCHD only).</p> <p>[LAST CLIP]: Deletes the last recorded clip. (Page 29)</p> <ul style="list-style-type: none"> • You cannot delete clips if the following operations are performed after shooting. <ul style="list-style-type: none"> - When switched to <PB> mode - When changing the recording format - When connecting to a computer using a USB cable - When powering off the camera - When opening the memory card slot cover <p>[BACKLIGHT]: Auto iris control for the backlight compensation</p> <p>[SPOTLIGHT]: Switches auto iris control ON/OFF for the spotlight.</p> <p>[BLACKFADE]: Black fade (Page 27)</p> <p>[WHITEFADE]: White fade (Page 27)</p>
[USER2]	<CAMERA> <PB>	<p>Sets the function assigned to the <USER2> button. The setting contents are the same as [USER1].</p> <p>[D.ZOOM]</p>
[USER3]	<CAMERA> <PB>	<p>Sets the function assigned to the <USER3> button. The setting contents are the same as [USER1].</p> <p>[SHOT MARK]</p>
[WFM]	<CAMERA>	<p>Switches the WAVE FORM display that appears when the <WFM> button is pressed.</p> <p>[WAVE]: Displays as a waveform.</p> <p>[VECTOR]: Displays as a vector.</p> <p>[WAVE/ VECTOR]: Each press of the button moves to the next setting in a sequence of [OFF]→[WAVE]→[VECTOR]→, and [OFF].</p>

_____ is the factory default mode.

Item	Display mode	Description of settings
[LCD]	<CAMERA> <PB>	Sets the function assigned to the <LCD> button. [LCD REV]: Flips the image displayed on the LCD vertically and horizontally. [LCD BL]: Selects the brightness of the LCD backlight. <ul style="list-style-type: none"> The setting selected using the <LCD> button is reflected in the setting of the [LCD BACKLIGHT] item on the [DISPLAY SETUP] screen.
[FACE FRAMING]	<CAMERA>	Frames the faces detected during operation of the [FACE DETECT] function with the USER button. The maximum number of detected frames is 15, and faces bigger and closer to the center of the screen are given priority. [OFF]: Frames are not displayed. [PRIMARY]: Displays only the high-priority frames. [ALL]: Displays all frames. <ul style="list-style-type: none"> Displays the high-priority frames with an orange border. Focuses on high-priority frames and adjusts brightness.

_____ is the factory default mode.

[AUTO SW] screen

Item	Display mode	Description of settings
[A.IRIS]	<CAMERA>	[ON]: Activates auto iris control when in Auto mode. In this mode, the <IRIS> button is disabled. [OFF]: Deactivates auto iris control when in Auto mode. Performs iris control operation selected using <IRIS> button.
[AGC]	<CAMERA>	Sets auto gain control operation when [ON] is selected in the [A.IRIS] item. [OFF]: Deactivates auto gain control when in Auto mode. Performs gain control operation selected using <GAIN> switch. [6dB]: Activates auto gain control with a maximum of 6 dB when in Auto mode. [12dB]: Activates auto gain control with a maximum of 12 dB when in Auto mode. [18dB]: Activates auto gain control with a maximum of 18 dB when in Auto mode.
[ATW]	<CAMERA>	[ON]: Activates [ATW] (Auto Tracking White) function when in Auto mode. At this time, the [ATW] function operation cannot be switched [ON]/[OFF] using the <WHITE BAL> switch or the USER button. However, if you have assigned [ATW LOCK] to the USER button, you can use the USER button to fix the white balance value. [OFF]: Deactivates the [ATW] function when in Auto mode. Activates white balance function selected using the <WHITE BAL> switch.
[AF]	<CAMERA>	[ON]: Activates auto focus when in Auto mode. At this time, the <FOCUS> switch is disabled. [OFF]: Deactivates auto focus when in Auto mode. Performs focus operation selected using <FOCUS> switch.

_____ is the factory default mode.

[RECORDING SETUP] screen

Item	Display mode	Description of settings
[HD/SD MODE]	<CAMERA>	Switches the mode AVCHD/DV. [AVCHD], [DV] • If the [TURN POWER OFF] message is displayed, switch the camera OFF and then ON again. Switching the camera ON/OFF switches the mode.
[REC FORMAT]	<CAMERA>	<p>■ AVCHD mode</p> <p>Selects the recording format. (Page 14)</p> <ul style="list-style-type: none"> [PH 1080/24P] and [PH 720/24P] are for native recording. <p>[PH 1080/60i], [PH 1080/30P], [PH 1080/24P], [PH 720/60P], [PH 720/30P], [PH 720/24P], [PM 720/60P], [HA 1080/60i], [HE 1080/60i]</p> <p>■ DV mode</p> <p>Selects the recording format. (Page 14)</p> <p>[DV 480/60i], [DV 480/30P], [DV 480/24P]</p>
[ASPECT CONV]	<CAMERA> (DV mode only)	Selects aspect ratio for DV mode recording. [SIDE CROP]: Records in 4:3. Crops the left and right edges. [LETTER BOX]: Records in 16:9. Adds black bands at the top and bottom of the screen. [SQUEEZE]: Records with horizontal compression of picture.
[PREREC MODE]	<CAMERA>	Sets the pre recording to ON or OFF. [ON]: Enables the pre-rec function. [OFF]: Disables the pre-rec function. • [TCG] is set to [FREE RUN]. • The INTERVAL REC setting will be released.
[SIMUL REC]	<CAMERA>	Records the same images to both memory card slots. (Page 32) [ON]: Enables the simul recording. [OFF]: Enables the normal recording.
[RELAY REC]	<CAMERA>	[ON]: Enables the relay recording. When the memory card used for recording has no remaining space, recording continues on another memory card if the memory card that can be used for recording is inserted in another memory card slot. [OFF]: Relay recording is not performed. Recording stops when the selected memory card has no remaining space.

_____ is the factory default mode.

Item	Display mode	Description of settings
[INTERVAL REC]	<CAMERA> (AVCHD mode only)	Scenes changing slowly over a long period are recorded as short movies by providing a recording interval. One frame is recorded in each recording time period that has been set, and in the AVCHD mode 24 frames form a one-second video. [OFF], [1SECOND], [10SECONDS], [30SECONDS], [1MINUTE], [2MINUTES] When INTERVAL REC is enabled, set the recording format as follows. If the recording format is not set to the following, the [INTERVAL REC] item of the [RECORDING SETUP] screen is grayed out and cannot be enabled. [PH 1080/24P] <ul style="list-style-type: none"> • When set to [PH 1080/24P], TC RECRUN is fixed to NDF. • The maximum shooting time is 168 hours. • Audio recording is disabled.
[TIME STAMP]	<CAMERA>	Enables a function to superimpose [DATE]/[TIME] information over the shot images. [ON]: The information set in the [DATE]/[TIME] item is superimposed. [OFF]: Date and time information are not superimposed on the image.
[AUDIO LIMITER CH1]	<CAMERA>	Enables the limiter function on CH1 audio input. [ON]: Level is reduced only when input exceeds limit (adjustable using <AUDIO LEVEL> knob). [OFF]: No limiter (adjustable using <AUDIO LEVEL> knob)
[AUDIO LIMITER CH2]	<CAMERA>	Enables the limiter function on CH2 audio input. [ON]: Level is reduced only when input exceeds limit (adjustable using <AUDIO LEVEL> knob). [OFF]: No limiter (adjustable using <AUDIO LEVEL> knob)
[MIC GAIN1]	<CAMERA>	Sets the input level of the external microphone connected to the AUDIO INPUT1 terminal. [-40dB], [-50dB], [-60dB]
[MIC GAIN2]	<CAMERA>	Sets the input level of the external microphone connected to the AUDIO INPUT2 terminal. [-40dB], [-50dB], [-60dB]

_____ is the factory default mode.

[TC/UB SETUP] screen

Item	Display mode	Description of settings
[TC MODE]	<CAMERA>	<p>Selects the correction mode of the internal time code when the time code of the internal time code generator is recorded.</p> <p>[DF]: Uses the drop frame mode.</p> <p>[NDF]: Uses the non-drop frame mode.</p> <ul style="list-style-type: none"> Automatically set to [NDF] when you set the recording frame rate of the recording format to 24P.
[TCG]	<CAMERA>	<p>Sets the mode in which you advance the internal time code generator.</p> <p>[FREE RUN]: The time code is advanced regardless of the operation mode. A slight time error may occur when switching to <PB> mode if the frame rate is set to 24P.</p> <p>[REC RUN]: The time code is advanced when shooting.</p>
[TC PRESET]	<CAMERA>	<p>Sets the initial time code.</p> <p>When you set the frame rate of the recording format to 24P, set the frame value to 0 or a multiple of 4 in AVCHD mode and to 5 frame units in DV mode. If any other value is set, the recorded time code will mismatch.</p> <p>[YES] [NO]</p>
[UB MODE]	<CAMERA> (DV mode only)	<p>Sets the content to be recorded as the user information.</p> <p>[USER]: Records the user information.</p> <p>[TIME]: The time is recorded.</p> <p>[DATE]: The date and time are recorded.</p> <p>[TCG]: Records the value of the time code generator.</p> <p>[FRAME RATE]: Records the frame rate information of frame conversion.</p>
[UB PRESET]	<CAMERA>	<p>Sets the user information.</p> <p>[YES] [NO]</p>
[EXT TC LINK]	<CAMERA>	<p>Synchronizes the initial time code value during multi-camera shooting. ([SLAVE] camera time codes are synchronized to the [MASTER] internal [TCG] value.)</p> <p>[MASTER]: Sets the mode to master mode.</p> <p>[SLAVE]: Sets the mode to slave mode. When the <RESET/TC SET> button is pressed, input time codes are synchronized to the internal [TCG].</p> <p>[NO]: Returns to the previous screen.</p> <ul style="list-style-type: none"> [MASTER] and [SLAVE] mode settings are in effect only when this menu is open. When the menu is closed, [EXT TC LINK] is automatically canceled.

_____ is the factory default mode.

[AV OUT SETUP] screen

Item	Display mode	Description of settings
[HDMI OUT SEL]	<CAMERA> <PB> (AVCHD mode only)	Sets the video format of the <HDMI> output. [1080i/720P]: Outputs at the resolution set in [REC FORMAT]. [DOWN CONV]: <HDMI> is output at 480P.
[DOWNCON MODE]	<CAMERA> <PB> (AVCHD mode only)	Switches down-conversion output mode. [SIDE CROP]: Crops the left and right edges. Images output from the external output terminals <VIDEO OUT>, <HDMI> will have portions which extend beyond the edges of the screen and cannot be seen. [LETTER BOX]: Adds black bands at the top and bottom of the image. [SQUEEZE]: Squeezes images horizontally.
[HP MODE]	<CAMERA>	Selects the sound heard from the headphones. [LIVE]: The sound input from the microphone is output as is. This setting is selected when delays in the sound are annoying. [RECORDING]: The sound in the status to be recorded (the sound synchronized with the images) is output.
[TEST TONE]	<CAMERA>	Sets test tone output to channels 1 and 2 when BARS setting is ON. [LEVEL1]: Outputs the 1 kHz test tone. [LEVEL2]: Test tone is output at lower volume than LEVEL1. [OFF]: Does not output the test tone.
[VIDEO SETUP]	<CAMERA> <PB>	Sets the setup level of video signals. [0%]: <VIDEO OUT> terminal output and recording setup levels will both be set to 0%. [7.5%A]: <VIDEO OUT> terminal output setup level will be set to 7.5%, while recording setup level will be set to 0%.
[AUDIO OUT]	<CAMERA> <PB>	Sets the audio signals to output from the <AUDIO OUT> terminal (A/V OUT). [CH1/CH2]: CH1 terminal = CH1 signals, CH2 terminal = CH2 signals [CH1]: CH1 terminal = CH1 signals, CH2 terminal = CH1 signals [CH2]: CH1 terminal = CH2 signals, CH2 terminal = CH2 signals <ul style="list-style-type: none"> When a memory card containing 5.1 channel content recorded on another equipment is played back on the camera, it is down-mixed to 2 channels when output through the <AUDIO OUT> and headphone terminals.

_____ is the factory default mode.

[DISPLAY SETUP] screen

Item	Display mode	Description of settings
[ZEBRA DETECT1]	<CAMERA>	Selects the brightness level of the right-leaning zebra patterns on the screen. [105%], [100%], [95%], [90%], [85%], [80%], [75%], [70%], [65%], [60%], [55%], [50%]
[ZEBRA DETECT2]	<CAMERA>	Selects the brightness level of the left-leaning zebra patterns on the screen. [OFF], [105%], [100%], [95%], [90%], [85%], [80%], [75%], [70%], [65%], [60%], [55%], [50%]
[Y GET MARKER]	<CAMERA>	Sets the display of the marker used for displaying the luminance level to [ON]/[OFF]. Select [ON] to display the marker by pressing the <ZEBRA> button. [ON], [OFF]
[SAFETY ZONE]	<CAMERA>	Sets [SAFETY ZONE]. ■ AVCHD mode [90%]: 90% display at 16:9 [4:3]: 100% display at 4:3 [14:9]: 100% display at 14:9 (the size between 16:9 and 4:3) [1.85:1]: 100% display at 1.85:1 (the size of American vista) [2:1]: 100% display at 2:1 (scope size) [2.35:1]: 100% display at 2.35:1 (the size of Cinemascope) [2.39:1]: 100% display at 2.39:1 [GRID]: 16:9 angular field of view with nine grid lines [OFF]: The SAFETY ZONE is not displayed. ■ DV mode [90%]: 90% display at 16:9 [4:3]: 100% display at 4:3 [OFF]: The SAFETY ZONE is not displayed.

_____ is the factory default mode.

Item	Display mode	Description of settings
[CENTER MARKER]	<CAMERA>	Sets the marker display to [ON]/[OFF]. Select [ON] to display the marker by pressing the <ZEBRA> button. [ON], [OFF]
[FOCUS BAR]	<CAMERA>	Sets the FOCUS ASSIST bar display to [ON]/[OFF]. Select [ON] to display the FOCUS ASSIST bar. [ON], [OFF]
[IRIS METER]	<CAMERA>	Sets [IRIS METER] display. [ON]: Displays the difference from an optimum value for the brightness of the image, as judged by the camera. The bar appears on the right: The image is too bright. The bar appears on the left: The image is too dark. [OFF]: IRIS METER is not displayed.
[REC COUNTER]	<CAMERA>	Selects counter operation during shooting. [TOTAL]: The count continues to increase until the <COUNTER> button is pressed to reset it. [CLIP]: Resets the counter at the start of recording and counts the time of each recording session. • The count is not displayed in <PB> mode.
[VIDEO OUT OSD]	<CAMERA> <PB>	Select [ON] to output the information displayed on the viewfinder or LCD monitor together with the signals. [ON], [OFF] • The external outputs <VIDEO OUT>, <HDMI> include items that are not displayed.
[DATE/TIME]	<CAMERA> <PB>	Sets whether to display the date and time on the viewfinder or LCD monitor and whether to output the date and time. [OFF]: The date and time are not displayed. [TIME]: The time is displayed. [DATE]: The date is displayed. [TIME&DATE]: The date and time are displayed.
[DATE FORMAT]	<CAMERA> <PB>	Changes the style of displaying the year, month, and day. [Y/M/D]: Year/Month/Day [M/D/Y]: Month/Day/Year [D/M/Y]: Day/Month/Year
[LEVEL METER]	<CAMERA> <PB>	Switches the audio level meter display [ON]/[OFF]. [ON], [OFF]
[ZOOM& FOCUS]	<CAMERA>	Selects the unit of zoom and focus values. [OFF], [NUMBER], [mm/m], [mm/feet] • The [mm/feet] display and [mm/m] display may be in error, so please use them as approximations.

_____ is the factory default mode.

Item	Display mode	Description of settings
[CARD& BATTERY]	<CAMERA> <PB>	Select [ON]/[OFF] to display/hide the remaining memory card recording capacity and remaining battery charge. [ON], [OFF]
[OTHER DISPLAY]	<CAMERA> <PB>	Selects how much information to display on the viewfinder and LCD monitor. [OFF], [PARTIAL], [ALL]
[LCD SET]	<CAMERA> <PB>	Adjusts the display level of images on the LCD monitor. [BRIGHTNESS]: brightness [COLOR]: color level [CONTRAST]: contrast
[EVF SET]	<CAMERA> <PB>	Adjusts the display level of images on the viewfinder. [BRIGHTNESS]: brightness [COLOR]: color level [CONTRAST]: contrast
[LCD BACKLIGHT]	<CAMERA> <PB>	Adjusts the backlight of the LCD monitor. [+1], [0], [-1], [-2], [-3] [+1]: The backlight becomes brighter. [-3]: The backlight becomes the darkest.
[SELF SHOOT]	<CAMERA>	Switches the LCD monitor to mirror mode for self-portrait shooting. Select [MIRROR] to flip the left and right side of the LCD monitor image during self-portrait shooting. [NORMAL], [MIRROR]
[EVF MODE]	<CAMERA> <PB>	Switches the screen display of images. [AUTO]: If you open the LCD monitor, images on the viewfinder disappear. [ON]: Images are always displayed on the viewfinder.
[EVF COLOR]	<CAMERA> <PB>	Switches viewfinder images to color/black and white. [ON]: Color [OFF]: Black and white

_____ is the factory default mode.

[CARD FUNCTIONS] screen

Item	Display mode	Description of settings
[CARD FORMAT]	<CAMERA> <PB>	Formats memory card. [SLOT1]: Formats the memory card inserted in slot 1. [SLOT2]: Formats the memory card inserted in slot 2. [NO]: Returns to the previous screen.
[CARD STATUS]	<CAMERA> <PB>	Displays the memory card status. [SLOT1]: Displays information about the memory card inserted in slot 1. [SLOT2]: Displays information about the memory card inserted in slot 2. [NO]: Returns to the previous screen.
[CLIP PROPERTY]	<PB>	Displays information about the selected clip. [YES]: Displays clip information. [NO]: Returns to the previous screen. This can also be displayed using the <DISP/MODE CHK> button.

_____ is the factory default mode.

[USER FILE] screen

Item	Display mode	Description of settings
[CARD READ]	<CAMERA> <PB>	Reads the user files saved on the memory card. [SLOT1]: Reads user files from the memory card inserted in slot 1. [SLOT2]: Reads user files from the memory card inserted in slot 2. [NO]: Returns to the previous screen.
[CARD WRITE]	<CAMERA> <PB>	Saves user files on the memory card. You can also add a title to the saved files. [SLOT1]: Saves user file on the memory card inserted in slot 1. [SLOT2]: Saves user file on the memory card inserted in slot 2. [NO]: Returns to the previous screen.
[LOAD/SAVE/INIT]	<CAMERA> <PB>	[LOAD]: Loads the settings in a previously stored user file. [SAVE]: Saves the updated user file settings. [INIT]: Returns the settings in the user file to the factory settings. [NO]: Returns to the previous screen. <ul style="list-style-type: none"> • After performing [LOAD] or [INIT], turn POWER/MODE switch of the camera OFF and then ON again to enable the new settings. • When [INIT] is executed, the setting value of the scene file, time code, the [TIME ZONE] item, the [CLOCK SET] item, and the [TIME ZONE] item remain unchanged.

_____ is the factory default mode.

[META DATA] screen (AVCHD mode only)

Item	Display mode	Description of settings
[CARD READ]	<CAMERA> (AVCHD mode only)	Loads the metadata recorded on the memory card into the camera. [SLOT1] [SLOT2] [NO] • [NO FILE] is displayed when there is no metadata recorded on the memory card.
[RECORD]	<CAMERA> (AVCHD mode only)	Sets whether to simultaneously record the metadata on a memory card as it is loaded into the camera. [ON]: Records simultaneously. [OFF]: Does not record simultaneously.
[USER CLIP NAME]	<CAMERA> (AVCHD mode only)	Sets [USER CLIP NAME] recording method. [TYPE1]: The user clip name is the same as the [CLIP NAME] if no metadata is uploaded or if no uploaded data exists. [TYPE2]: The user clip name is the same as the [CLIP NAME] if no combination of data and COUNT value is uploaded, or if no uploaded data exists.
[META DATA PROP]	<CAMERA> (AVCHD mode only)	Displays the metadata recorded in the unit. [YES] [NO]
[CLIP COUNTER RST]	<CAMERA> (AVCHD mode only)	Resets the COUNT value to 1. [YES] [NO]
[META INIT SET]	<CAMERA> (AVCHD mode only)	Initializes the metadata recorded in the unit. All settings, including the [ON]/[OFF] setting for [RECORD] are cleared. [YES] [NO]

_____ is the factory default mode.

[OTHER FUNCTIONS] screen

Item	Display mode	Description of settings
[IR REMOTE]	<CAMERA> <PB>	Sets the operations of the supplied remote control unit. [ON]: Accepts commands from the remote control. • Note that if the same type of remote control is used near the unit, the unit may receive commands from the other remote control during shooting, for example, and suddenly operate in an unexpected manner. [OFF]: Does not accept commands from the remote control.
[DV CONTROL]	<CAMERA> (DV mode only)	Specifies the control method when a backup device is connected to the <DV OUT> terminal for backup recording. [OFF]: Backup device is not controlled. [EXT]: Backup device controlled using <START/STOP> button. Note, however, that recording on the camera is not performed. [BOTH]: Backup recording performed by the unit and the backup device. [CHAIN]: When the recording nears the end, recording on the backup device which is on standby will automatically start.

_____ is the factory default mode.

Item	Display mode	Description of settings																																																																																																												
[DV CMD SEL]	<CAMERA> (DV mode only)	Sets the recording operation to be performed by the backup device when you press the <START/STOP> button. [REC P]: Pauses and unpauses the recording. [STOP]: Starts and stops the recording.																																																																																																												
[TALLY LAMP]	<CAMERA>	Sets lighting of the tally lamp. [FRONT]: The front tally lamp (microphone side) lights. [REAR]: The rear tally lamp (viewfinder side) lights. [BOTH]: Both tally lamps light. [OFF]: No tally lamp lights.																																																																																																												
[CLOCK SET]	<CAMERA> <PB>	Sets the built-in calendar of the camera.																																																																																																												
[TIME ZONE]	<CAMERA> <PB>	Adds to or deducts from GMT the time value of [-12:00] to [+13:00] in 30-minute steps. (Refer to the following table.) [0:00]																																																																																																												
		<table border="1"> <thead> <tr> <th>Time difference</th> <th>Region</th> <th>Time difference</th> <th>Region</th> </tr> </thead> <tbody> <tr><td>+00:00</td><td>Greenwich</td><td>-00:30</td><td></td></tr> <tr><td>-01:00</td><td>Azores</td><td>-01:30</td><td></td></tr> <tr><td>-02:00</td><td>Mid-Atlantic</td><td>-02:30</td><td></td></tr> <tr><td>-03:00</td><td>Buenos Aires</td><td>-03:30</td><td>Newfoundland Island</td></tr> <tr><td>-04:00</td><td>Halifax</td><td>-04:30</td><td></td></tr> <tr><td>-05:00</td><td>New York</td><td>-05:30</td><td></td></tr> <tr><td>-06:00</td><td>Chicago</td><td>-06:30</td><td></td></tr> <tr><td>-07:00</td><td>Denver</td><td>-07:30</td><td></td></tr> <tr><td>-08:00</td><td>Los Angeles</td><td>-08:30</td><td></td></tr> <tr><td>-09:00</td><td>Alaska</td><td>-09:30</td><td>Marquesas Islands</td></tr> <tr><td>-10:00</td><td>Hawaii</td><td>-10:30</td><td></td></tr> <tr><td>-11:00</td><td>Midway Islands</td><td>-11:30</td><td></td></tr> <tr><td>-12:00</td><td>Kwajalein Atoll</td><td>+12:30</td><td></td></tr> <tr><td>+13:00</td><td></td><td>+11:30</td><td>Norfolk Island</td></tr> <tr><td>+12:00</td><td>New Zealand</td><td>+10:30</td><td>Lord Howe Island</td></tr> <tr><td>+11:00</td><td>Solomon Islands</td><td>+09:30</td><td>Darwin Islands</td></tr> <tr><td>+10:00</td><td>Guam</td><td>+08:30</td><td></td></tr> <tr><td>+09:00</td><td>Tokyo</td><td>+07:30</td><td></td></tr> <tr><td>+08:00</td><td>Beijing</td><td>+06:30</td><td>Yangong</td></tr> <tr><td>+07:00</td><td>Bangkok</td><td>+05:30</td><td>Mumbai</td></tr> <tr><td>+06:00</td><td>Dacca</td><td>+04:30</td><td>Kabul</td></tr> <tr><td>+05:00</td><td>Islamabad</td><td>+03:30</td><td>Tehran</td></tr> <tr><td>+04:00</td><td>Abu Dhabi</td><td>+02:30</td><td></td></tr> <tr><td>+03:00</td><td>Moscow</td><td>+01:30</td><td></td></tr> <tr><td>+02:00</td><td>Eastern Europe</td><td>+00:30</td><td></td></tr> <tr><td>+01:00</td><td>Central Europe</td><td></td><td></td></tr> </tbody> </table>	Time difference	Region	Time difference	Region	+00:00	Greenwich	-00:30		-01:00	Azores	-01:30		-02:00	Mid-Atlantic	-02:30		-03:00	Buenos Aires	-03:30	Newfoundland Island	-04:00	Halifax	-04:30		-05:00	New York	-05:30		-06:00	Chicago	-06:30		-07:00	Denver	-07:30		-08:00	Los Angeles	-08:30		-09:00	Alaska	-09:30	Marquesas Islands	-10:00	Hawaii	-10:30		-11:00	Midway Islands	-11:30		-12:00	Kwajalein Atoll	+12:30		+13:00		+11:30	Norfolk Island	+12:00	New Zealand	+10:30	Lord Howe Island	+11:00	Solomon Islands	+09:30	Darwin Islands	+10:00	Guam	+08:30		+09:00	Tokyo	+07:30		+08:00	Beijing	+06:30	Yangong	+07:00	Bangkok	+05:30	Mumbai	+06:00	Dacca	+04:30	Kabul	+05:00	Islamabad	+03:30	Tehran	+04:00	Abu Dhabi	+02:30		+03:00	Moscow	+01:30		+02:00	Eastern Europe	+00:30		+01:00	Central Europe		
Time difference	Region	Time difference	Region																																																																																																											
+00:00	Greenwich	-00:30																																																																																																												
-01:00	Azores	-01:30																																																																																																												
-02:00	Mid-Atlantic	-02:30																																																																																																												
-03:00	Buenos Aires	-03:30	Newfoundland Island																																																																																																											
-04:00	Halifax	-04:30																																																																																																												
-05:00	New York	-05:30																																																																																																												
-06:00	Chicago	-06:30																																																																																																												
-07:00	Denver	-07:30																																																																																																												
-08:00	Los Angeles	-08:30																																																																																																												
-09:00	Alaska	-09:30	Marquesas Islands																																																																																																											
-10:00	Hawaii	-10:30																																																																																																												
-11:00	Midway Islands	-11:30																																																																																																												
-12:00	Kwajalein Atoll	+12:30																																																																																																												
+13:00		+11:30	Norfolk Island																																																																																																											
+12:00	New Zealand	+10:30	Lord Howe Island																																																																																																											
+11:00	Solomon Islands	+09:30	Darwin Islands																																																																																																											
+10:00	Guam	+08:30																																																																																																												
+09:00	Tokyo	+07:30																																																																																																												
+08:00	Beijing	+06:30	Yangong																																																																																																											
+07:00	Bangkok	+05:30	Mumbai																																																																																																											
+06:00	Dacca	+04:30	Kabul																																																																																																											
+05:00	Islamabad	+03:30	Tehran																																																																																																											
+04:00	Abu Dhabi	+02:30																																																																																																												
+03:00	Moscow	+01:30																																																																																																												
+02:00	Eastern Europe	+00:30																																																																																																												
+01:00	Central Europe																																																																																																													
[LANGUAGE]	<CAMERA> <PB>	Sets the Menu language. [English], [Español], [Français]																																																																																																												
[SYSTEM INFO]	<CAMERA> <PB>	Displays the version of the system in this camera.																																																																																																												
[MENU INIT]	<CAMERA>	Returns the menu settings (scene files and user files) to factory default settings. (Except for time code/[OPERATION TIME] item/[CLOCK SET] item/[TIME ZONE] item settings)																																																																																																												
[OPERATION TIME]	<CAMERA> <PB>	Displays the power-on time (a 5-digit figure).																																																																																																												

_____ is the factory default mode.

[OPTION MENU] screen

Item	Display mode	Description of settings
[1394 STATUS]	<CAMERA> (DV mode only)	Displays IEEE1394 status. [YES] [NO]
[1394 CONFIG]	<CAMERA> (DV mode only)	Sets IEEE1394. [DFLT], [1] - [255]

[OPTION MENU] is displayed when you press the <MENU> button while holding down the <DISP/MODE CHK> button.

_____ is the factory default mode.

[PLAY SETUP] screen

Item	Display mode	Description of settings
[PB FORMAT]	<PB> (AVCHD mode only)	Sets the playback format. [1080/60i(30P)], [1080/24P], [720/60P(30P)], [720/24P] • The [REC FORMAT] setting in the <CAMERA> mode prior to migrating to the PB mode becomes the default value of the [PB FORMAT].
[REPEAT PLAY]	<PB>	[ON] [OFF] When [ON] is selected, supported clips are played repeatedly.
[RESUME PLAY]	<PB>	[ON] [OFF] When [ON] is selected, playback resumes from the video position where clip playback had stopped.
[SKIP MODE]	<PB> (AVCHD mode only)	Selects the starting position for cued playback after pausing. [CLIP]: Stops playback at the beginning of the previous clip. [CLIP & INDEX]: Stops at the beginning of the clip and the INDEX.

_____ is the factory default mode.

[THUMBNAIL] screen

Item	Display mode	Description of settings
[THUMBNAIL MODE]	<PB>	Selects the thumbnail display method. [ALL]: Displays all clips. [SAME FORMAT]: Displays clips in the same recording format. (AVCHD mode only) [MARKER]: Displays clips with shot marks. [INDEX]: Displays clips with an INDEX. (AVCHD mode only)
[INDICATOR]	<PB>	Sets whether or not to display the indicator. [ON]: Displays indicator. [OFF]: Does not display indicator.
[DATA DISPLAY]	<PB>	Selects the information to be displayed in the time display area of the clips. [TC]: Time code [UB]: User information [TIME]: Shooting time [DATE]: Shooting date [DATE&TIME]: Shooting date and time
[DATE FORMAT]	<PB>	Selects display order for [DATE] or [DATE&TIME] of the [DATA DISPLAY] item. [Y/M/D]: Year/Month/Day [M/D/Y]: Month/Day/Year [D/M/Y]: Day/Month/Year

_____ is the factory default mode.

[OPERATION] screen

Item	Display mode	Description of settings
[DELETE]	<PB>	Deletes clips. [ALL CLIPS]: Deletes all clips. [SELECT]: Deletes only the selected clips. Press <EXEC> to delete. [NO]: Returns to the previous screen. <ul style="list-style-type: none"> Clips for which CLIP PROTECT is specified are not deleted.
[INDEX]	<PB> (AVCHD mode only)	Adds or deletes an [INDEX] to a clip. [YES]: Displays. [NO]: Does not display.
[CLIP PROTECT]	<PB> (AVCHD mode only)	Protects clips to prevent accidental deletion. [YES]: Enables clip protection or releases protection. [NO]: Returns to the previous screen. <ul style="list-style-type: none"> Formatting the memory card will delete all clips even if they are protected.
[REPAIR]	<PB> (DV mode only)	Restores defective clips. (Page 58)

_____ is the factory default mode.

Before calling for service

Power supply

Cannot turn on the power.	<ul style="list-style-type: none"> • Make sure the battery and AC adaptor are connected properly. Check the connections again. 	Pages 23, 24 of Vol.1
Power goes off as soon as it is switched on.	<ul style="list-style-type: none"> • The battery may have run out. If the remaining battery charge display is blinking or [] appears, the battery has run out. Either recharge the battery or replace the discharged battery with a fully charged one. 	Page 22 of Vol.1

Battery

Battery runs out quickly.	<ul style="list-style-type: none"> • Make sure the battery is fully charged. Keep charging until the <CHARGE> lamp on the AC adaptor goes out. • The camera may be used in a low-temperature environment. The battery is affected by the ambient temperature. In low-temperature locations, its operating time will shorten. • The battery may have reached the end of its service life. Every battery has a certain service life. The service life varies depending on how it is used, and if the operating time has reduced significantly even after the battery was sufficiently charged, the battery may have reached the end of its service life. 	Page 21 of Vol.1
The battery cannot be charged.	<ul style="list-style-type: none"> • A DC cord may be connected to the AC adaptor. The battery cannot be charged with the DC cord connected. 	Page 21 of Vol.1
The remaining charge is not displayed correctly.	<ul style="list-style-type: none"> • The remaining battery charge display is merely a guideline. To ensure that remaining battery capacity is displayed correctly, use the battery completely from a fully-charged state, and charge the battery again. (Remaining battery capacity may still not be displayed correctly if the battery has been used for long periods in high or low temperatures, or if the battery has been recharged a large number of times.) 	—

Shooting

Cannot start shooting.	<ul style="list-style-type: none"> • Make sure that the POWER/MODE switch is <ON>. 	Page 27 of Vol.1
Cannot focus automatically.	<ul style="list-style-type: none"> • Make sure the camera is in manual focus mode. You can focus automatically when the auto focus mode is selected. • Depending on the lens, the auto focus function may not be available. • You may be shooting a scene where it is difficult to bring the subject into focus in the auto focus mode. If this is the case, focus in the manual focus mode. It may be hard to bring the subject into focus when <ul style="list-style-type: none"> - Shooting both close and distant objects - Shooting through a dirty window - Shooting in a dark location - There are sparkling or shiny objects around the subject - Shooting a fast-moving subject - Shooting a subject with minimal contrast 	P18

Cannot record even though the memory card is inserted correctly.	<ul style="list-style-type: none"> • The write-protect switch on the memory card may be in the <LOCK> position. The memory card cannot be recorded to if the switch is in the <LOCK> position. • The remaining memory on the memory card may be extremely low. Save the content onto other media and delete unnecessary data from the memory card, or use a new memory card instead. • The memory card may have been correctly formatted. Alternatively, the format itself may be incompatible with this camera. Reformat the memory card using the camera. • 8 MB to 16 MB memory cards cannot be used for shooting movies. 	<p>P15</p> <p>P13</p> <p>Page 11 of Vol.1</p>
Recording stops by itself.	<ul style="list-style-type: none"> • The memory card may not be compatible with video recording. Always use a memory card compatible with video recording. 	<p>Page 11 of Vol.1</p>

Editing

Cannot read the data on the memory card.	<ul style="list-style-type: none"> • Make sure the memory card has been correctly formatted. If not, format the memory card using the camera. 	<p>P13</p>
Cannot perform non-linear editing.	<ul style="list-style-type: none"> • Check the specifications of your computer and connection cable. 	<p>P64</p>
Cannot dub onto an external device.	<ul style="list-style-type: none"> • Make sure the external device connected correctly. 	<p>P64</p>

Displays

Something is wrong with the time code display.	<ul style="list-style-type: none"> • The time code display may not register a regular count if a clip is played back in the reverse slow mode, but this is normal. 	<p>—</p>
---	---	----------

Playback

Cannot play back content even when I press the play button.	<ul style="list-style-type: none"> • Make sure the camera is in the <CAMERA> mode. Turn the POWER/MODE switch and confirm that the PB lamp <PB> is lit. • Make sure that the playback format matches the data. Match the playback format with the recording format of the clip. 	<p>P50</p>
Mosaic-like noise appears when fast-forwarding or rewinding a clip.	<ul style="list-style-type: none"> • This noise is inherent to digital video technology. It does not indicate a fault. 	<p>—</p>
Images do not appear on the television even though I have connected the camera-recorder correctly.	<ul style="list-style-type: none"> • Make sure that the input selector on your television is set to video input. Read the instructions of your television carefully and select the correct video input connector for the camera. 	<p>—</p>
Cannot hear any sound from the camera's speaker.	<ul style="list-style-type: none"> • You may have turned down the camera's volume control too far. Adjust the volume level by pressing the <AUDIO MON/ADV> button <+>. 	<p>P62</p>

PC connection

Computer does not recognize camera when USB2.0 connection cable is connected.	<ul style="list-style-type: none"> • Check the operating environment. • If your computer has multiple USB2.0 terminals, try connecting the camera to a different USB terminal. • Switch off the camera and then on again and reconnect the USB2.0 connection cable. 	P64
An error message appears on the computer when the USB2.0 connection cable is disconnected.	<ul style="list-style-type: none"> • To disconnect the USB2.0 connection cable safely, double-click the icon in the task tray and follow the instructions on the screen. 	—

Other

The remote control does not work.	<ul style="list-style-type: none"> • The battery in the remote control may have run out. If the remote control fails to work even it is operated close to the remote control sensor of the camera, the battery may have run out. Replace the battery. • Make sure the [IR REMOTE] item on the setting menu [OTHER FUNCTIONS] screen is not set to [OFF]. 	Page 26 of Vol.1
There is a rattling sound when the camera is tilted back and forth.	<ul style="list-style-type: none"> • This is the sound of the lens moving. This is normal. The sound will not be heard when the camera is switched on. 	—
A clicking sound is heard when the power is turned on or when the <PB> mode is switched to the <CAMERA> mode.	<ul style="list-style-type: none"> • This initialization operation is performed when the camera starts up. It occurs due to the construction of the camera and does not indicate a fault. 	—
The memory card screen is abnormal.	<ul style="list-style-type: none"> • The data on the memory card could be corrupted. Data can be corrupted by static electricity and electromagnetic waves. Always save important data to a computer or other storage media. 	—
The memory card cannot be used even after formatting.	<ul style="list-style-type: none"> • There could be a fault with the camera or with the memory card. Please consult your dealer. Always use memory cards of 512 MB - 64 GB with this camera. 	—
The camera does not recognize the memory card when it is inserted.	<ul style="list-style-type: none"> • The inserted memory card may have been originally formatted with a computer. Always use this camera to format memory cards. Please be aware that, when a memory card is formatted, all data recorded on the memory card will be erased and cannot be restored. 	P13
The memory card is not recognized when inserted into other devices.	<ul style="list-style-type: none"> • Check that the device is compatible with the size and type (SD memory card/SDHC Memory Card/SDXC Memory Card) of the memory card you are using. For details, please refer to the device's own operating instructions. 	Page 11 of Vol.1
Image burn-in occurs in the LCD monitor.	<ul style="list-style-type: none"> • If the same image or text is displayed continuously for a long time, image burn-in may occur on the screen, but this can be resolved by turning off the power for a few hours. 	—

The changeover between clips may not always be smooth when playing back multiple clips in succession. In the AVCHD mode, video may momentarily pause when playing back multiple clips in succession under circumstances such as those detailed as follows.

■ **Mixture of different recording formats**

Recording mode = PH mode
 Playback format = 1080/60i (30P)

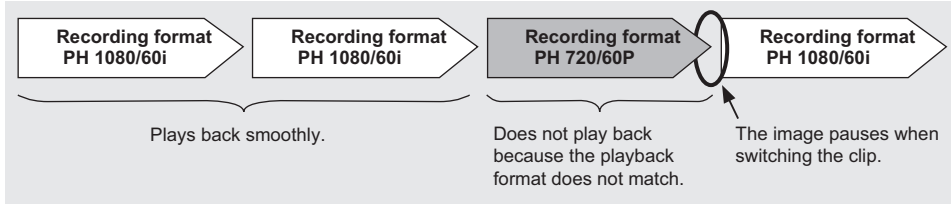

■ **Mixture of different recording modes**

Recording format = 1080/60i
 Playback format = 1080/60i (30P)

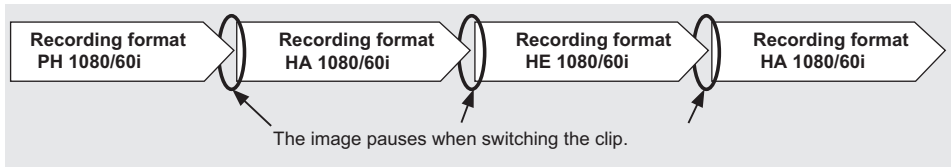

■ **Some clips have been recorded using PRE REC function**

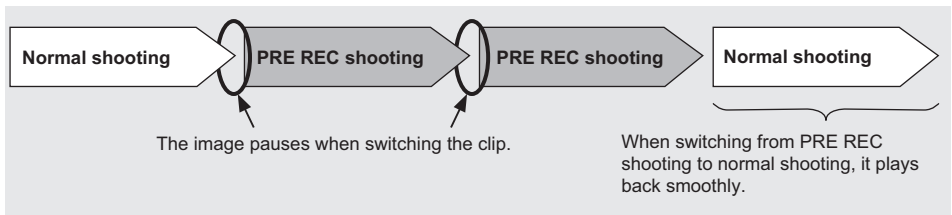

■ **Some clips have a recording time of less than 3 seconds**

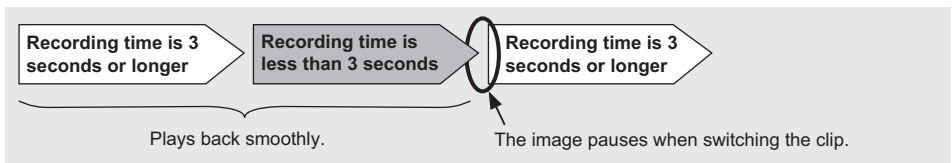

Updating the firmware incorporated into the unit

To check the latest information on the firmware and update methods, refer to the following support page on the Panasonic website.

<http://pro-av.panasonic.net/>

Cleaning

When cleaning, do not use benzene or thinner.

- Benzene or paint thinners may deform the camera body and/or cause the surface finish to peel.
- Before proceeding with maintenance, remove the battery or disconnect the AC cord from the power outlet.
- Wipe the camera-recorder with a soft, clean cloth. To remove stubborn dirt, wipe the camera with a cloth moistened with kitchen detergent diluted in water and then finish with a dry cloth.

Cleaning the viewfinder

If there is dust in the viewfinder, remove the eye cup holder and get rid of the dust.

- The interior of the eye cup holder is specially finished, so do not wipe it under any circumstances. If dust has adhered, blow it off with an air blower.
- Remove the eye cup holder by rotating counterclockwise with the eye cup attached. (It has been tightly screwed on.) When you do this, tilt the viewfinder slightly upward.
- To mount the eye cup holder, align the ridges and grooves of the eye cup holder and camera-recorder, and turn clockwise until the holder clicks into place.

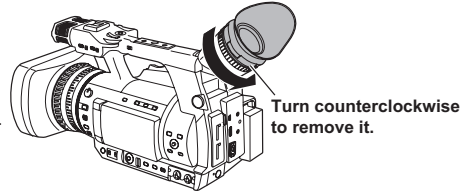
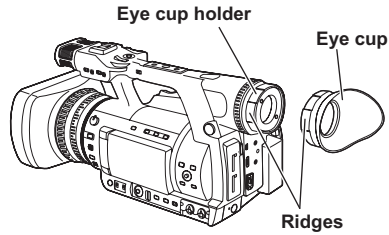

Storage precautions

Before storing the camera, remove both the memory card and battery.

Store all of these items in place with low humidity and relatively constant temperature.

Recommended temperature range: 15°C - 25°C

Recommended relative humidity: 40% - 60%

Camera-recorder

- Wrap the camera-recorder in a soft cloth to keep the dust off.

Battery

- The service life of the battery will be shortened when exposed to extreme temperatures.
- Storing the battery in a location with oily vapors or high dust concentration may result in corrosion to the terminals or other damage, leading to malfunction.

- **Keep metal objects (such as necklaces and hairpins) away from the terminals. Short-circuiting may occur across the terminals, causing the battery to heat up, you may seriously burn yourself if you touch the battery in this state.**

Memory card

- After ejecting a memory card from the camera-recorder, always put it in its own case.
- Do not leave memory cards in areas where corrosive gases, etc. are present.
- Do not leave the memory cards inside vehicles, in places exposed to direct sunlight or in other places where the temperature is high.
- Do not leave the memory cards where the humidity level is high or where there are high concentrations of dust.

Recording format list

Recording mode			Frame rate		
			60i	30P	24P
AVCHD	PH	1080/60i	1080/60i	1080/30P (over 60i)	1080/24P (Native recording)
		720/60P	720/60P	720/30P (over 60P)	720/24P (Native recording)
	PM	720/60P	720/60P	-	-
	HA	1080/60i	1080/60i	-	-
	HE	1080/60i	1080/60i	-	-
DV		480/60i	480/60i	480/30P (over 60i)	480/24P (over 60i)

Index

A		G	
AC adaptor	13, 47	Gain	20
Adjusting the volume		Gamma	80
Monitor volume while shooting	29	H	
Playback volume	62	HDMI cable	66
Recording level of audio signals	39	HD mode	27, 11
ATW	22	I	
AUDIO INPUT 1/ 2 terminal (XLR 3-pin)	38	IEEE1394	95
Audio pin cable	66	Index recording	29
Auto mode	11	INTERVAL REC	86
Auto Tracking White	22	Iris	19
AVCCAM Restorer	16	IRIS	19
AVCHD Format	69	L	
AVCHD mode	11, 27, 11	LAST CLIP	29
B		LCD monitor	14, 6
Backlight	8	Low angle shooting	24
Backlight compensation	27	M	
Black balance	22	Manual focus	18
Built-in microphone	37	Manual mode	18
C		Memory card	
Charge		Access lamp	12
Battery	13, 21	Format	13
Built-in battery	47	Inserting	10
Clip		Protection	15
Deleting	57	Recording data	69
Information	59	Recording time	14
Metadata	44	Removing	15
Playback	50, 51, 61	Repair	16
Protecting	57	Selecting the slot	12, 53
Repair	16, 58	Type	11, 12
Color bars	28	Microphone	
Computer	64	Built-in microphone	37
Connection		External microphone	38
Computer	64	Phantom microphone	38
External microphone	63	Microphone holder	63
Headphones	63	Mode lamp	50
TV/Monitor	66	N	
Counter	46	ND filter	20
D		Nonlinear editing	68
Diopter adjustment dial	5	O	
Dubbing	70	Optical image stabilizer	27
DV mode	11, 27, 11	P	
E		Playback	50
Error displays	77	Playback format	54
Eye cup	26	Pre-rec	30
F		Progressive mode	23
Firmware	101	P	
Focus	18	Playback	50
Focus assist	19	Playback format	54
Focus ring	18	Pre-rec	30
		Progressive mode	23

Bold/italic numbers in the style of (***00***) are a Volume 1 page numbers.
Numbers in the style of (00) are Volume 2 page numbers.

R

REC CHECK	12
Recording format	103
Relay function	31
Repeat playback	54
Resume playback.....	55

S

Scene files	29 , 40
Screen displays	71
SD mode	27 , 11
Self-portrait recording	24
Setup menu	
Initialization	29
List	79
Operation	28
Structure	32
Shooting.....	10
Shot mark	29
Shutter speed	34
SIMUL REC	32
Specifications	35
Synchro scan	36

T

Tally lamp	9
Thumbnail	
Display method	56
Thumbnail screen	51
Time code	47

U

USB2.0 connection cable	64
USER button	27
User information	49

V

Video pin cable	66
Viewfinder	5

W

Warning	76
Wave form monitor function	28
White balance	20

Z

Zebra patterns	25
ZOOM.....	17

Bold/italic numbers in the style of (***00***) are a Volume 1 page numbers.
Numbers in the style of (00) are Volume 2 page numbers.

Panasonic Corporation

Web Site: <http://panasonic.net>

© Panasonic Corporation 2011